

# Simplify Materials Selection

Your guide to making choices that reduce the impact of corrosion



Swagelok®

## Index

<b>Choose with Confidence</b>	<b>3</b>
<b>What is Corrosion</b>	<b>4</b>
<b>Steps to Control Corrosion</b>	<b>5</b>
<b>Identifying Types of Corrosion and Selecting Materials</b>	<b>6</b>
Finding Proper Materials	6
General (or Uniform) Corrosion	7
Localized Corrosion: Pitting and Crevice Corrosion	8
Pitting Corrosion	9
Crevice Corrosion	10
Stress Corrosion Cracking (SCC)	11
Sour Gas Cracking or Sulfide Stress Cracking (SSC)	12
Hydrogen Embrittlement	13
Intergranular Corrosion (IGC)	14
Galvanic Corrosion	15

316 Stainless Steel	16
6-Moly Alloys	17
Alloy 2507 Super Duplex Stainless Steel	18
Alloy 825	19
Alloy 625	20
Alloy C-276	21
Alloy 400	22
Titanium Alloys	23
Engineered Combinations	24
<b>Understanding Requirements and Standards</b>	<b>25</b>
NACE® Requirements	26
NACE MR0175/ISO 15156 Overview	27
NACE Requirements for Alloy 2507 Super Duplex Tube Fittings	28
NACE Requirements for Alloy 625 Standard and Medium-Pressure Tube Fittings	29
NACE Requirements for 6-Moly Alloy Tube, Pipe, and Weld Fittings	30
NORSOK Standards	31

<b>Learn More</b>	<b>33</b>
Materials Science Training	33
Additional Resources	34
Quality and Reliability	34
Product and Systems Training	35
Evaluation and Advisory Services	35
Custom Solutions	35
Find a Technical Advisor	35
Articles	36
Reference Guide	36
Product Test Reports	36
NACE	36
<b>Safe Product Selection</b>	<b>37</b>

An offshore platform can have nearly 50,000 feet of tubing, more than 20,000 fluid system components, no fewer than 10,000 fittings, and as many as 8,000 mechanical connections.

No wonder choosing one material isn't easy.

In fact, there are many considerations when specifying materials for instrumentation lines, hydraulic power, chemical injection, deluge systems, and much more.

That's where Swagelok can help. We've been fighting corrosion since 1947. We simplify selection with our deep understanding of factors that contribute to corrosion, as well as the properties of materials that help fight it. We use alloys with at least two, but often up to ten different elements in optimized concentrations which give our materials superior corrosion resistance that helps our products perform better.

For instance:

Nickel [Ni] + Copper [Cu] = Alloy 400 (Monel®)

Iron [Fe] + Nickel [Ni] + Chromium [Cr] + Molybdenum [Mo] = 316 Austenitic Stainless Steel

With stringent quality control measures, expert-led instruction, and authorized sales and service center support, Swagelok offers unmatched expertise in the world's toughest environments. We make material selection a matter of confidence for our customers. Swagelok can make the material difference in your operation.

### Fitting and Tubing Alloy Selection

Application and cost considerations

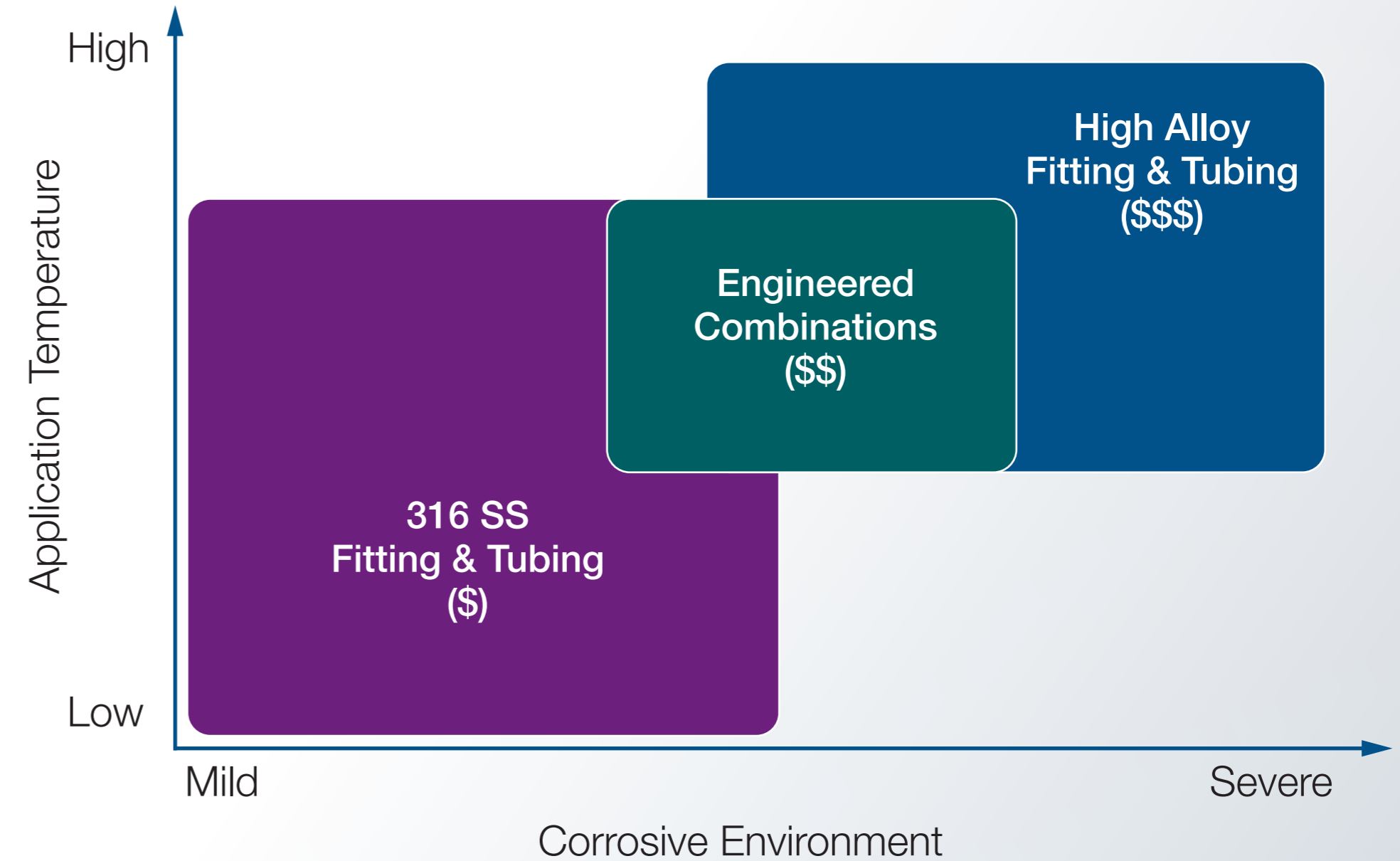

## Just about every metal corrodes under certain conditions.

Corrosion is the physical degradation of a material due to interactions with its environment. Corrosion occurs when a metal atom is oxidized by a fluid, leading to a loss of material in the metal surface. This loss reduces the wall thickness of a component and makes it more prone to mechanical failure. Just about every metal corrodes under certain conditions. For example, rust is a commonly occurring byproduct of corrosion, resulting from iron corroding and forming iron oxide. Many other types of corrosion exist, however. Each type poses a threat that must be evaluated when selecting the optimal material for your application.

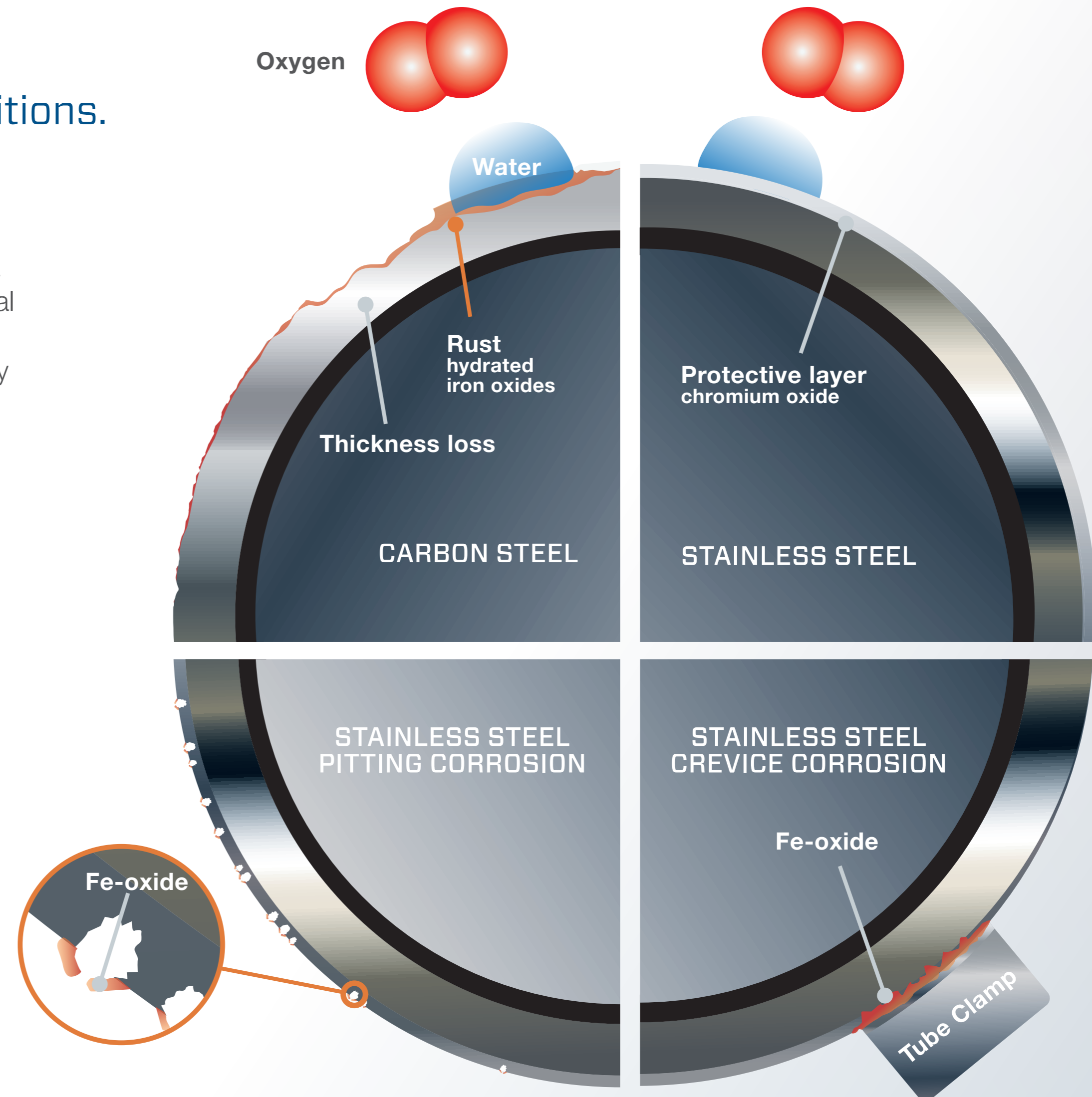

Total annual costs of corrosion are estimated at \$1.3 billion USD for the entire oil and gas production industry.

For oil and gas producers, the problem can be especially costly. NACE International estimated the total annual cost of corrosion at \$1.3 billion USD<sup>1</sup> for the entire oil and gas production industry. But when personnel can visually identify corrosion and know where to look for it, the risk can be minimized. Better yet, when engineers can anticipate corrosion and make the best choices, system integrity, longevity of assets, performance, and safety improve.

Take these steps to reduce the impact of corrosion on your applications:

- *Identify types of corrosion*—what it looks like, where it occurs, and why it happens
- *Select materials* resistant to corrosion
- Minimize locations where *crevice corrosion* can occur
- Avoid the contact of dissimilar metals, which can cause *galvanic corrosion*
- Specify everything from the *supports and clamps* to the *tubing* itself to reduce the potential for corrosion
- *Understand requirements and standards*
- *Learn more through training and other resources*

<sup>1</sup>Estimated by NACE International (NACE) 2002



## Finding a proper materials solution means starting at the source of the problem.

Begin here to learn more about the many types of corrosion, the materials that are affected most, and the materials with greater resistance to each type.



## General (or Uniform) Corrosion

Easily recognized: surface is uniformly affected by formation of “red rust”

**What it is:** The most well-known type of corrosion is also the easiest to spot and predict. It is unusual—but not unheard of—for general corrosion to lead to disastrous failures. For this reason, general corrosion is often regarded as an eyesore rather than a serious problem. General corrosion occurs relatively uniformly across a metal surface. The gradual decrease of the wall thickness of a component must be considered when calculating pressure ratings.

**How it forms:** In a marine or other corrosive environment, the surface of carbon or low-alloy steel begins to break down, allowing for the formation of an iron oxide scale which grows thicker in time until it spalls off and new scale forms.

### General corrosion can be measured by:

- How fast the material recedes on an annual basis. For example, unprotected carbon steel may recede in a marine environment by 1 mm every year.
- The weight loss that is experienced by an alloy when in contact with corrosive fluids, typically measured in milligrams per square centimeter of exposed material per day



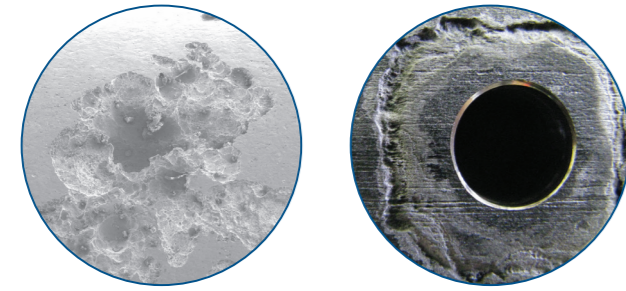

## Localized Corrosion: Pitting and Crevice Corrosion

Common in marine environments

**What it is:** Both pitting corrosion and crevice corrosion are more difficult to detect than general corrosion, making these types of corrosion more challenging to identify, predict, and design against.

**How it forms:** The material's protective oxide layer can break down when it is exposed to fluids which contain chlorides. A material is more resistant to localized corrosion the higher its Critical Pitting Temperature (CPT) and Critical Crevice Corrosion Temperature (CCCT). These are the minimum temperatures at which pitting and crevice corrosion are observed. Methods to measure CPT and CCCT are described in ASTM Standard G48.

➤ **Learn about pitting corrosion**

➤ **Learn about crevice corrosion**

**Material Matters:** For further reference, see [Preventing Pitting and Crevice Corrosion](#) as published in *World Oil*.

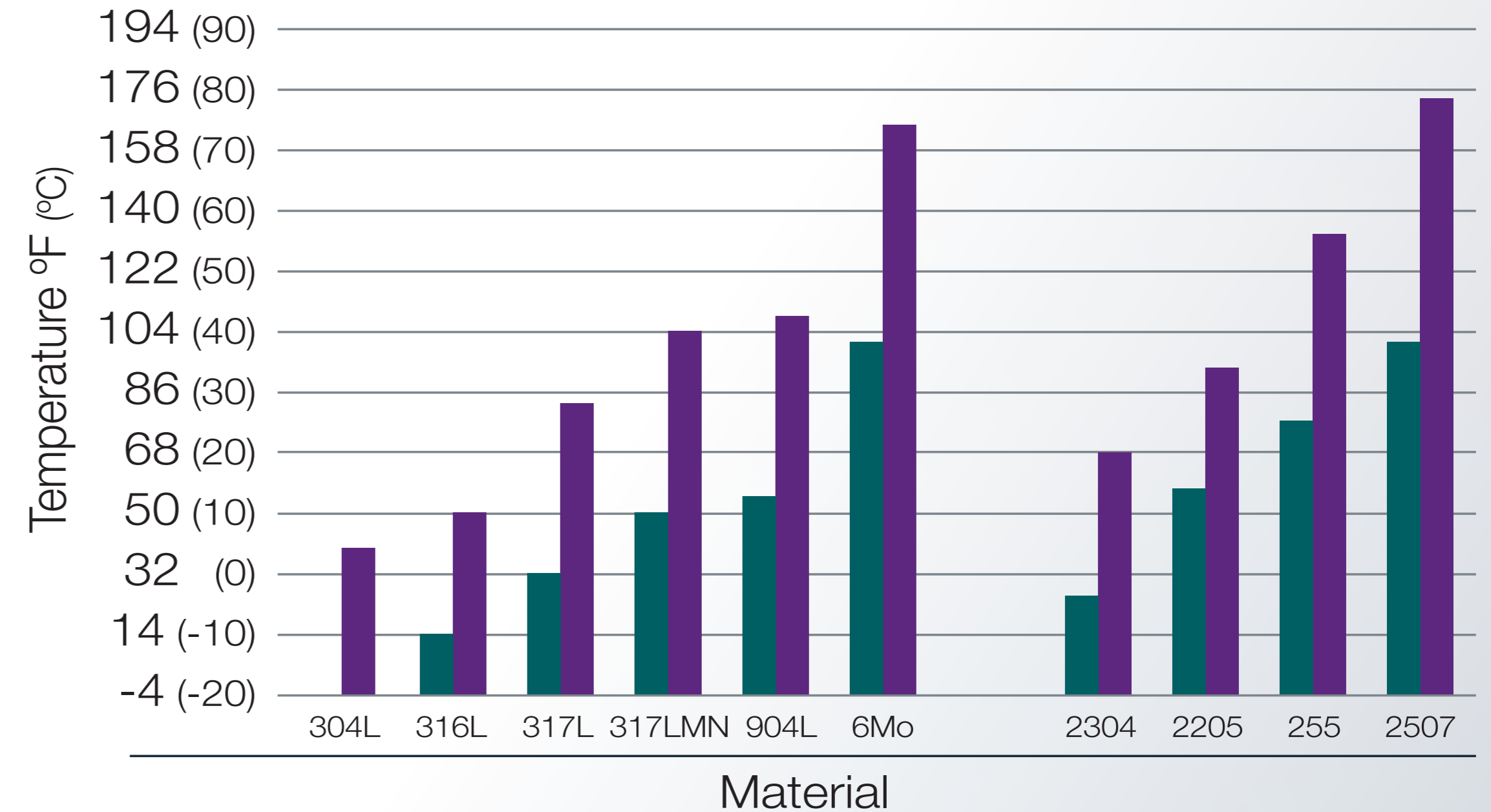

• Measured by ASTM G48 in 10% ferric chloride

■ CCCT ■ CPT

*Crevice corrosion can occur at lower temperatures than pitting corrosion. For instance, for 316L stainless steel in a 10% ferric chloride environment, pitting corrosion can start to occur at 10°C (50°F) whereas crevice corrosion can begin at -10°C (14°F).*

*Source: Practical Guidelines for the Fabrication of Duplex Stainless Steels, Int. Molybdenum Assoc., 2001*





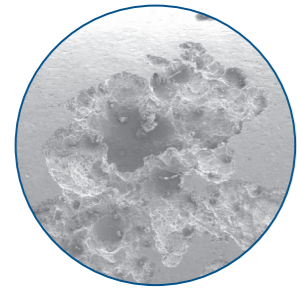

## Pitting Corrosion

Common in high-chloride environments at elevated temperatures

**What it is:** Pitting corrosion causes small cavities, or pits, to form on the surface of a material.

Although detectable by thorough visual inspection, these pits can grow deep enough to perforate tubing. Pitting is more often observed in high-chloride environments at elevated temperatures.

**How it forms:** When the protective layer of oxide (or passive oxide layer) on the surface of the metal breaks down, the metal becomes susceptible to loss of electrons. This causes iron in the metal to dissolve into a solution in the more anodic bottom of the pit, diffuse toward the top, and oxidize to iron oxide, or rust. The iron chloride solution concentration in a pit can increase and become more acidic as the pit gets deeper. These changes result in accelerated growth of the pit, perforation of tubing walls, and leaks.

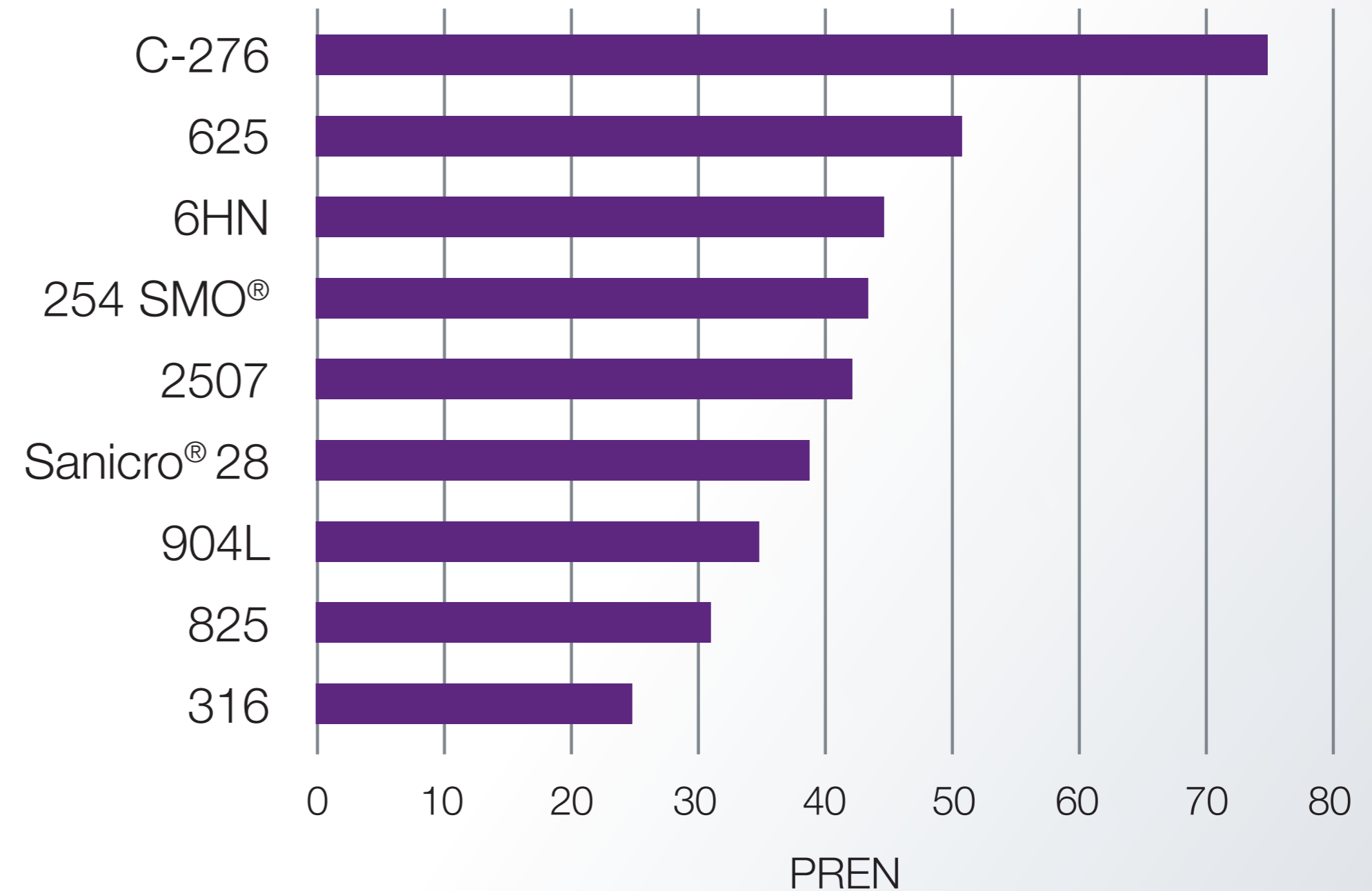

$$PREN = \%Cr + 3.3 \times (\%Mo + 0.5W) + 16 \times \%N$$

Higher PREN values indicate greater pitting corrosion resistance.

Pitting corrosion is best prevented by proper alloy selection. Different metals and alloys can be compared using their Pitting Resistance Equivalence Number (PREN), which is calculated from the chemical composition of the material. PREN increases with higher levels of chromium, molybdenum, and nitrogen.



## Crevice Corrosion

Localized corrosion associated with tight spaces

**What it is:** In a typical fluid system, crevices exist between tubing and tube supports or tube clamps, between adjacent tubing runs, and underneath dirt and deposits that may have accumulated on surfaces. Crevices are virtually impossible to avoid in tubing installations, and tight crevices pose the greatest danger for corrosion to occur.

**How it forms:** Like pitting corrosion, crevice corrosion starts with the breakdown of the passive oxide layer that protects the metal. This breakdown leads to the formation of small pits. The pits grow larger and deeper until they cover the whole crevice. In some places, tubing can be perforated. Crevice corrosion occurs at far lower temperatures than pitting corrosion.

**Material Matters:** When seawater diffuses into a crevice, some  $\text{Fe}^{++}$  ions dissolve and cannot rapidly diffuse out of a tight crevice. In salt water, negatively charged chloride ions ( $\text{Cl}^-$ ) are attracted by these positively charged  $\text{Fe}^{++}$  ions and begin to diffuse into the crevice. As the chloride concentration increases, the crevice solution becomes more corrosive, causing more iron to dissolve, which in turn attracts more chloride ions to diffuse into the crevice. Ultimately, the crevice solution turns into an acidic solution with high chloride concentration, which is very corrosive.

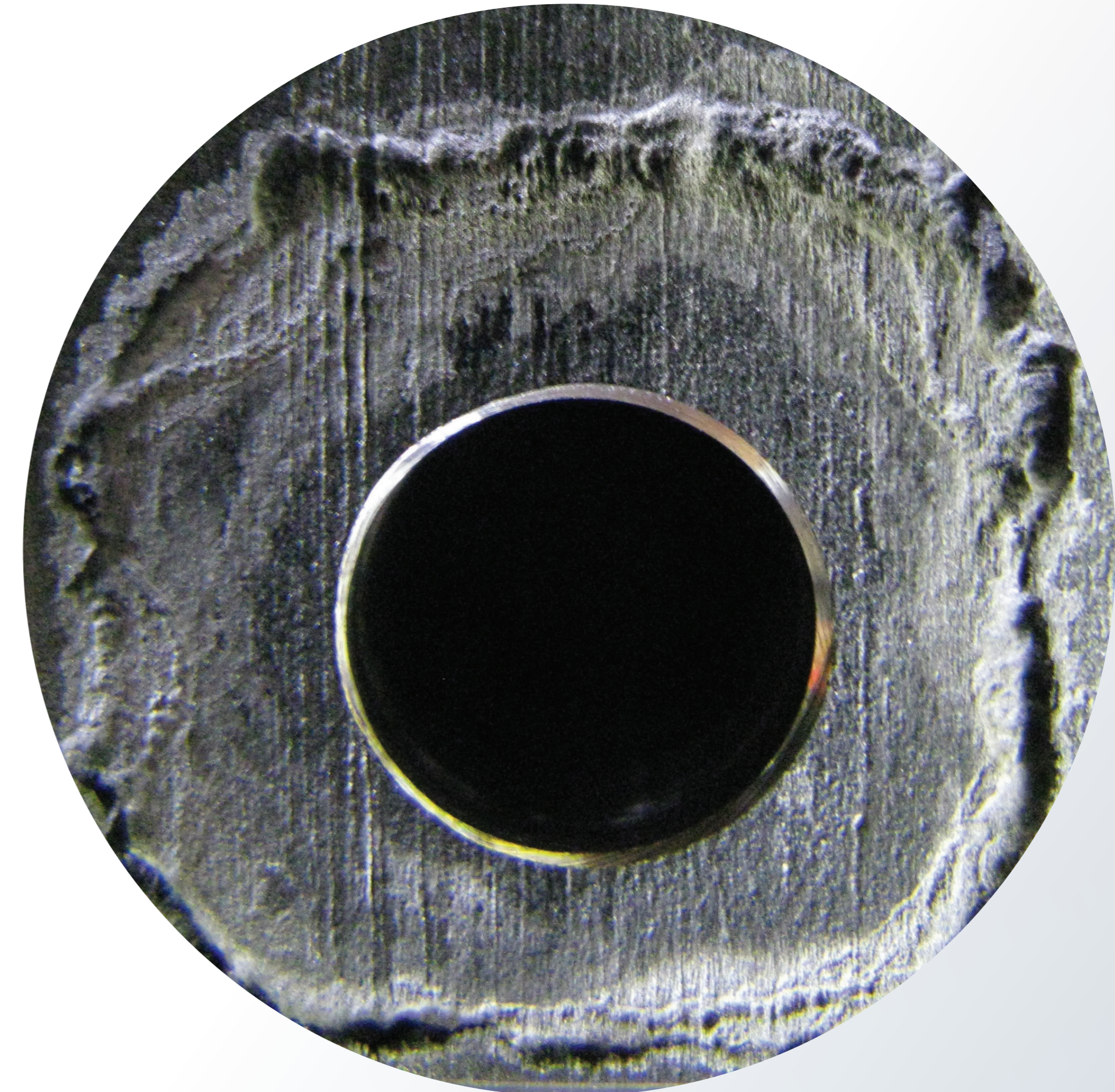

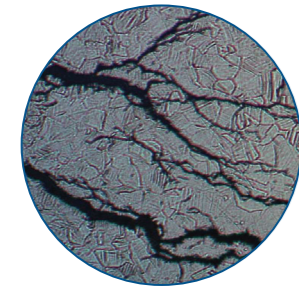

## Stress Corrosion Cracking (SCC)

Common in stainless steels (chloride-induced), mild steel (alkali-induced), and brass (ammonia-induced)

**What it is:** Stress corrosion cracking (SCC) is dangerous because it can destroy a component at stress levels below the yield strength of an alloy. In the presence of chloride ions, austenitic stainless steels are susceptible to SCC. The ions interact with the material at the tip of a crack where tensile stresses are highest, making it easier for the crack to grow. While in progress, SCC can be difficult to detect, and final failure can occur suddenly.

**How it forms:** For SCC to occur, three conditions must be met simultaneously:

- The metal must be susceptible to SCC
- Environmental (fluid or temperature) conditions conducive to SCC must exist
- The tensile stress (applied + residual) must be above critical level

**Materials resistant to chloride-induced SCC include:**

- Nickel-based alloys
- Duplex stainless steels

**Material Matters:** Learn more about selecting fluid system components for sour oilfields with Swagelok. Read the advice our leading expert has for [Offshore Magazine](#) readers.

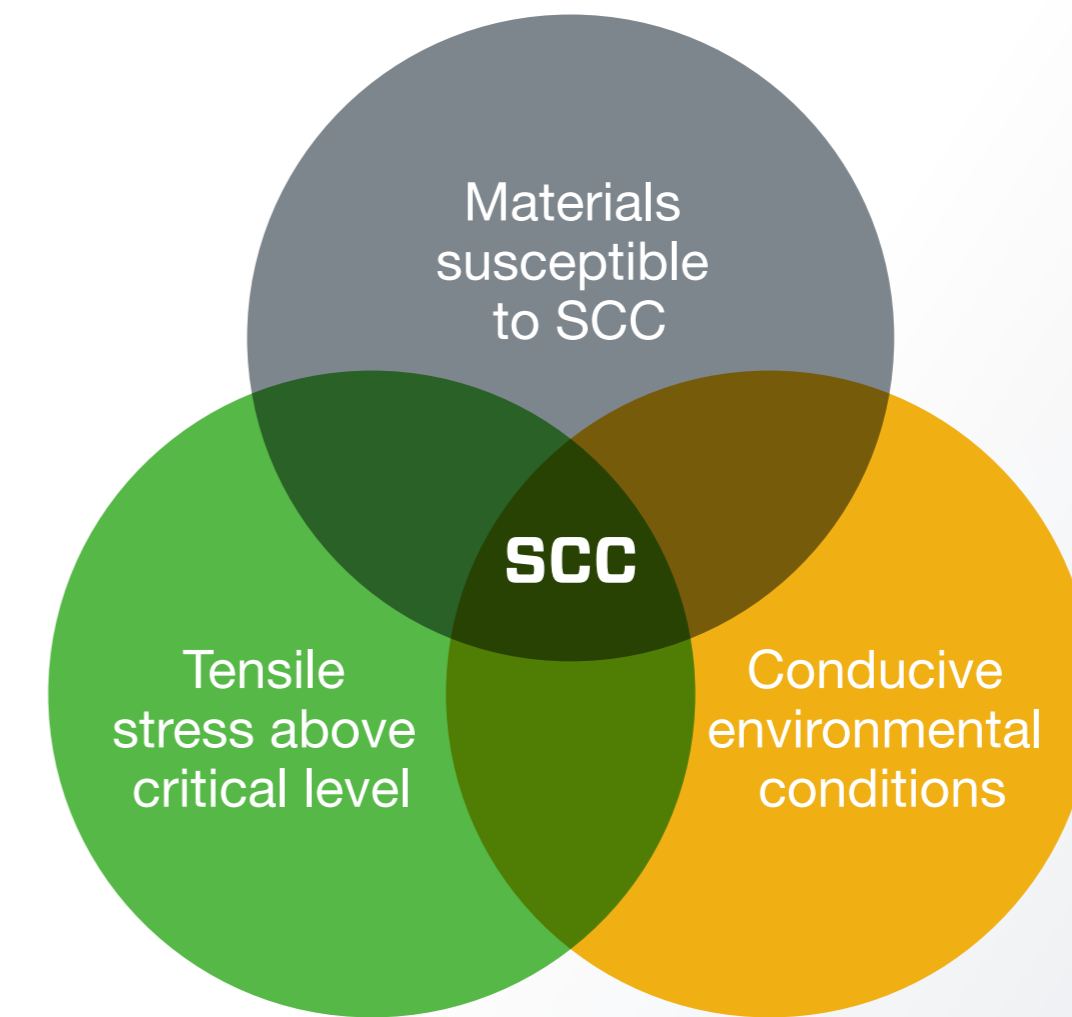

*Higher nickel content shows higher resistance to chloride-induced SCC.*

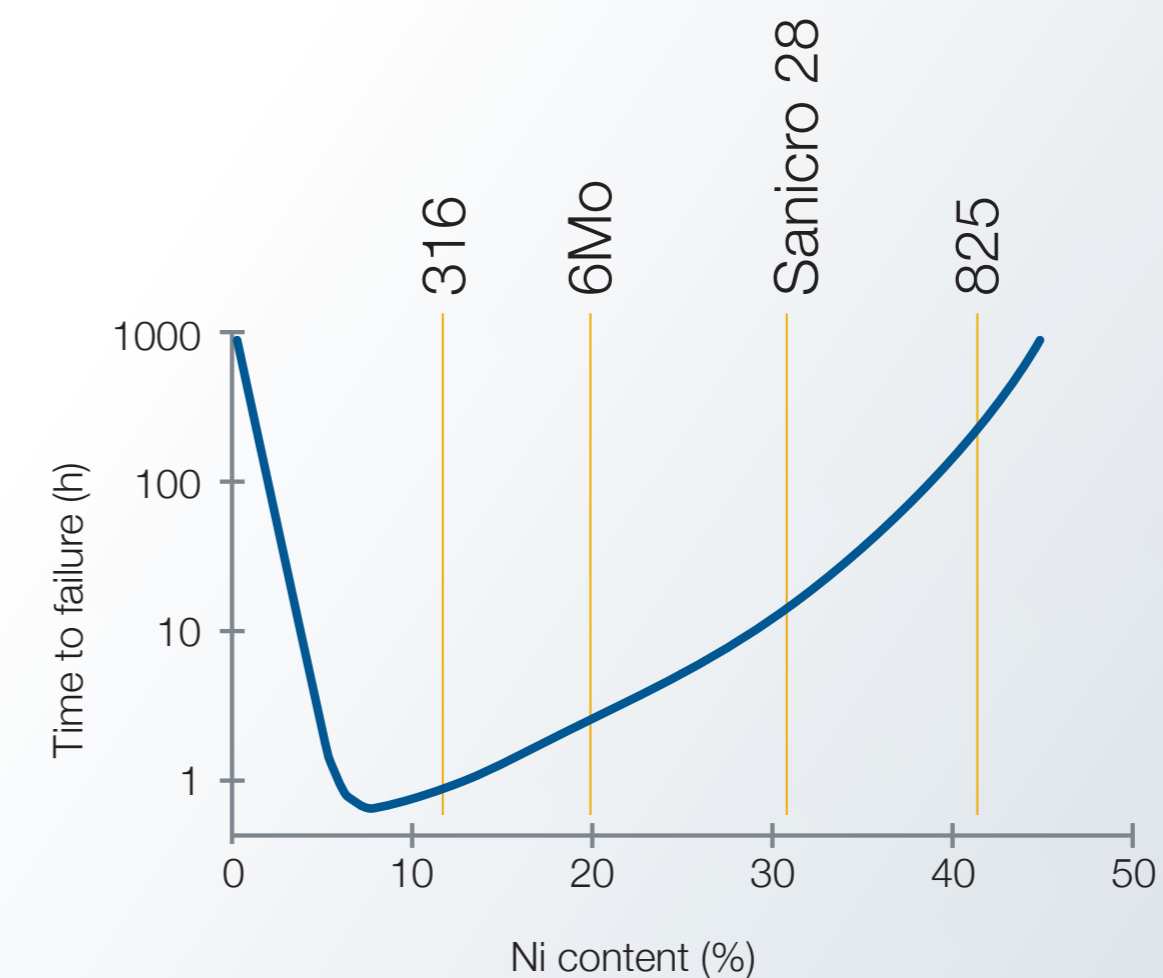

## Sour Gas Cracking or Sulfide Stress Cracking (SSC)

Common in new sour reservoirs and in aging reservoirs where seawater has been injected for enhanced oil recovery

**What it is:** Sour gas cracking, also known as sulfide stress cracking (SSC), is the deterioration of metal due to contact with hydrogen sulfide ( $H_2S$ ) and moisture.  $H_2S$  becomes severely corrosive in the presence of water. This condition can lead to embrittlement of the material, resulting in cracking under the combined action of tensile stress and corrosion.

**How it forms:** For SSC to occur, three conditions must be met simultaneously:

- The metal must be susceptible to SSC
- The environment must be sufficiently sour (high in  $H_2S$ )
- The tensile stress (applied + residual) must be above a critical level

The risk of SSC increases when the following factors increase:

- Material hardness/tensile strength
- Hydrogen ion concentration (lower pH value)
- $H_2S$  partial pressure
- Total tensile stress (applied + residual)
- Exposure time

The risk of SSC increases at lower temperatures where materials tend to be less ductile.

**Material Matters:** The [NACE MR0175/ISO 15156](#) standard describes suitable materials for sour environments in oil and gas production. For more help selecting components for sour oilfields, refer to this [article](#) published in *Offshore Magazine*.



Reprinted from Science Direct, Volume 1, Issue 3, S.M.R. Ziaei, A.H. Kokabi, M. Nasr-Esehani, Sulfide Stress Corrosion Cracking and Hydrogen Induced Cracking of A216-WCC Wellhead Flow Control Valve Body case study, Pages 223-224, July 2013 with permission from Elsevier.



## Hydrogen Embrittlement

Can occur in high-pressure gaseous hydrogen or when atomic hydrogen is generated at a metal surface

**What it is:** Hydrogen atoms can diffuse into metals, making them brittle. All materials susceptible to hydrogen embrittlement are also very susceptible to sulfide stress cracking.

**How it forms:** Hydrogen-induced cracking can occur if the metal is subject to static or cyclic tensile stress.

Hydrogen can cause changes in the mechanical properties and behavior of the metal, including:

- Reduction of ductility (elongation and reduction of area)
- Reduction of impact strength and fracture toughness
- Increased fatigue behavior

Hydrogen embrittlement can be avoided by selecting material resistant to hydrogen, such as austenitic alloys with nickel content between 10% and 30%.

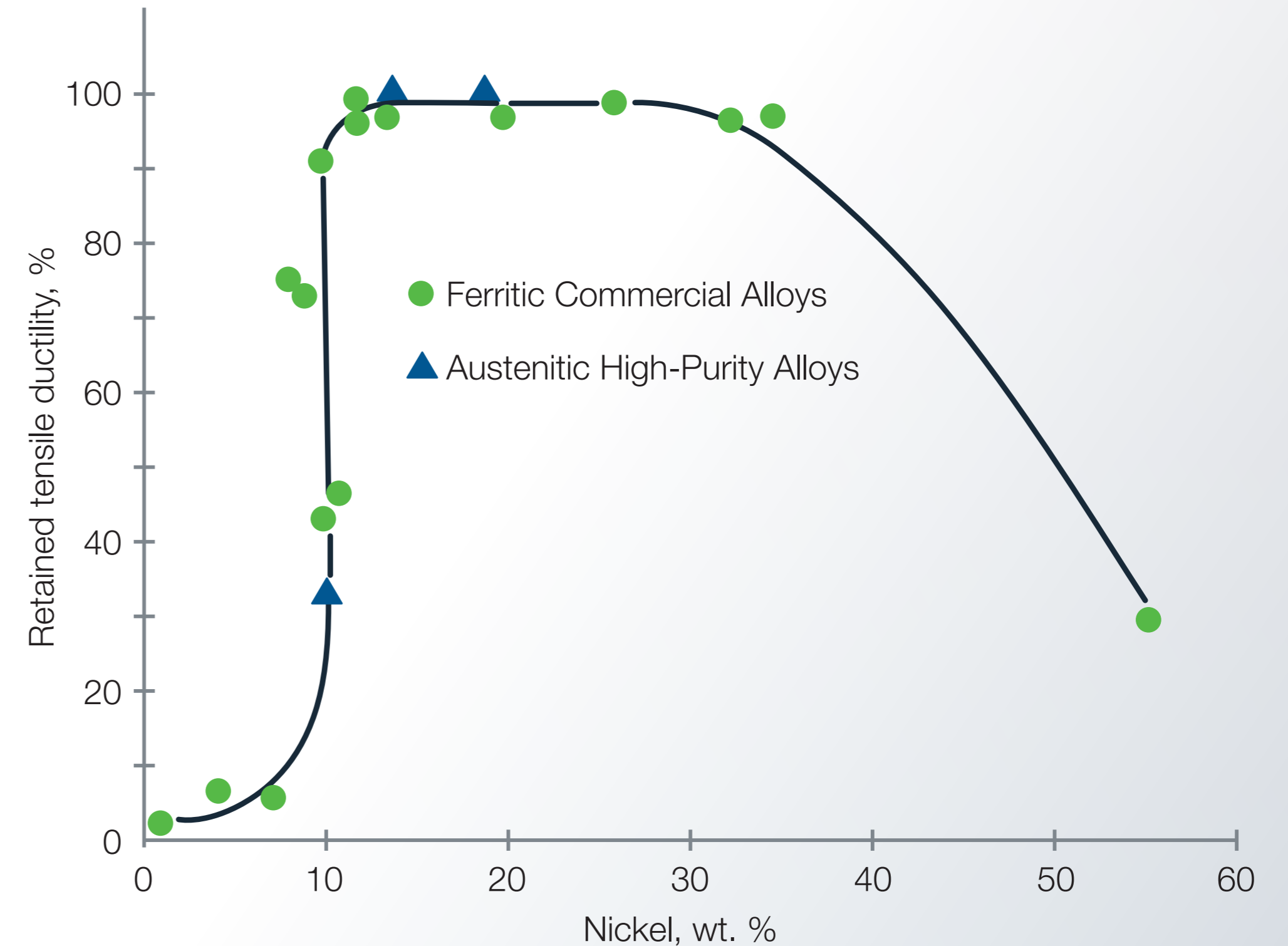

Ferritic alloys with very low nickel content become significantly embrittled, while austenitic alloys with nickel content between 10% and 30% show relatively little embrittlement.

Source: G.R. Caskey, *Hydrogen Compatibility Handbook for Stainless Steels* (1983)

## Intergranular Corrosion (IGC)

Common in welding operations, heat treatment, high-temperature applications

**What it is:** To understand IGC, consider that all metals consist of individual grains. Within each grain, the atoms are systematically arranged, forming a three-dimensional lattice. IGC attacks the material along the grain boundaries (where the grains that make up the metal come together).

**How it forms:** During welding, heat treatment, or exposure to high temperatures, carbides can begin to form on grain boundaries. These carbide precipitates can grow larger in time. This carbide formation affects the uniform distribution of elements within the metal by robbing material adjacent to grain boundaries of important elements, such as chromium. When corrosive fluids (like acids) attack the chromium-depleted regions, intergranular cracks can form. These cracks can propagate throughout a material and stay undetected, making IGC a dangerous form of corrosion.

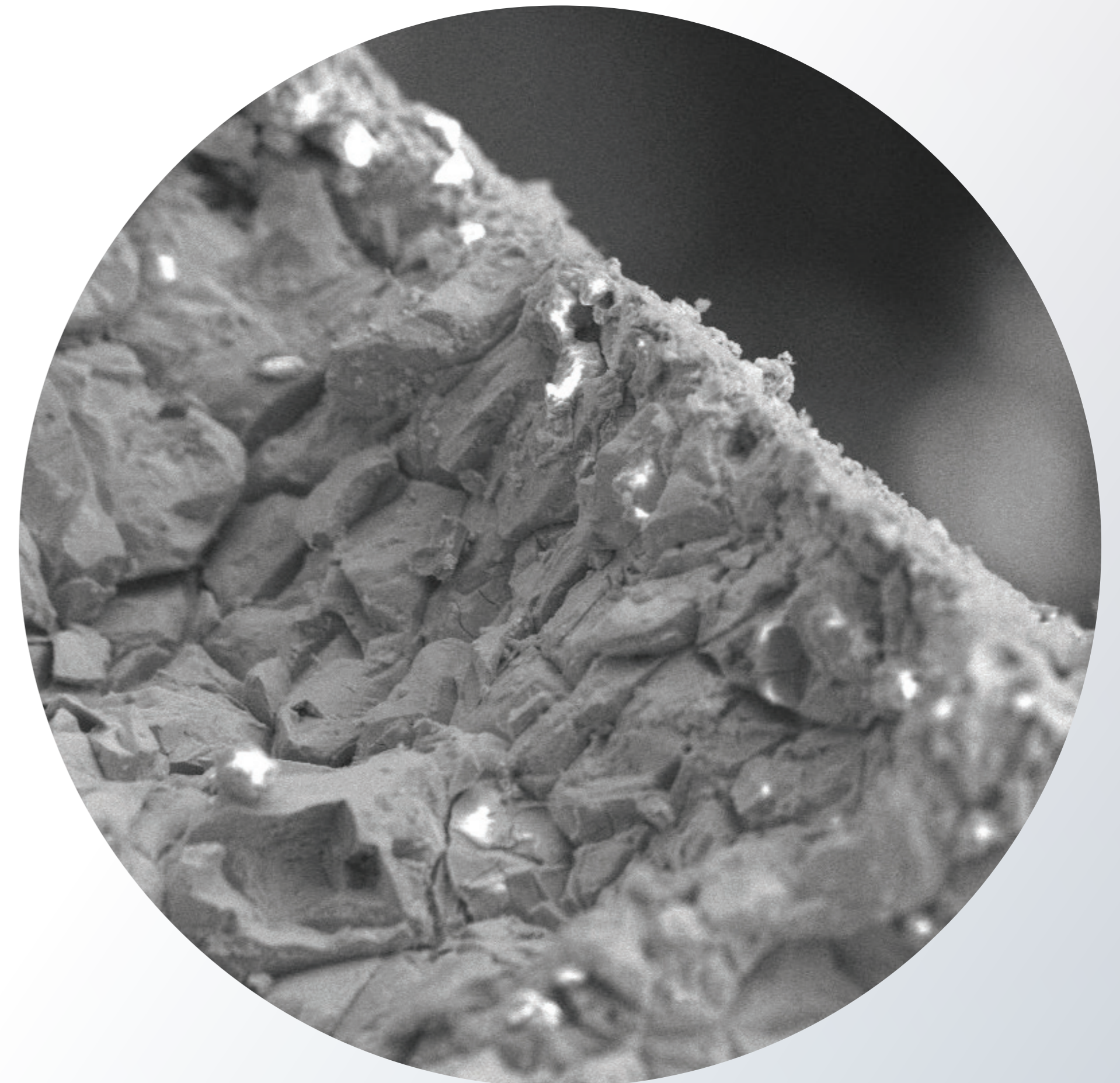
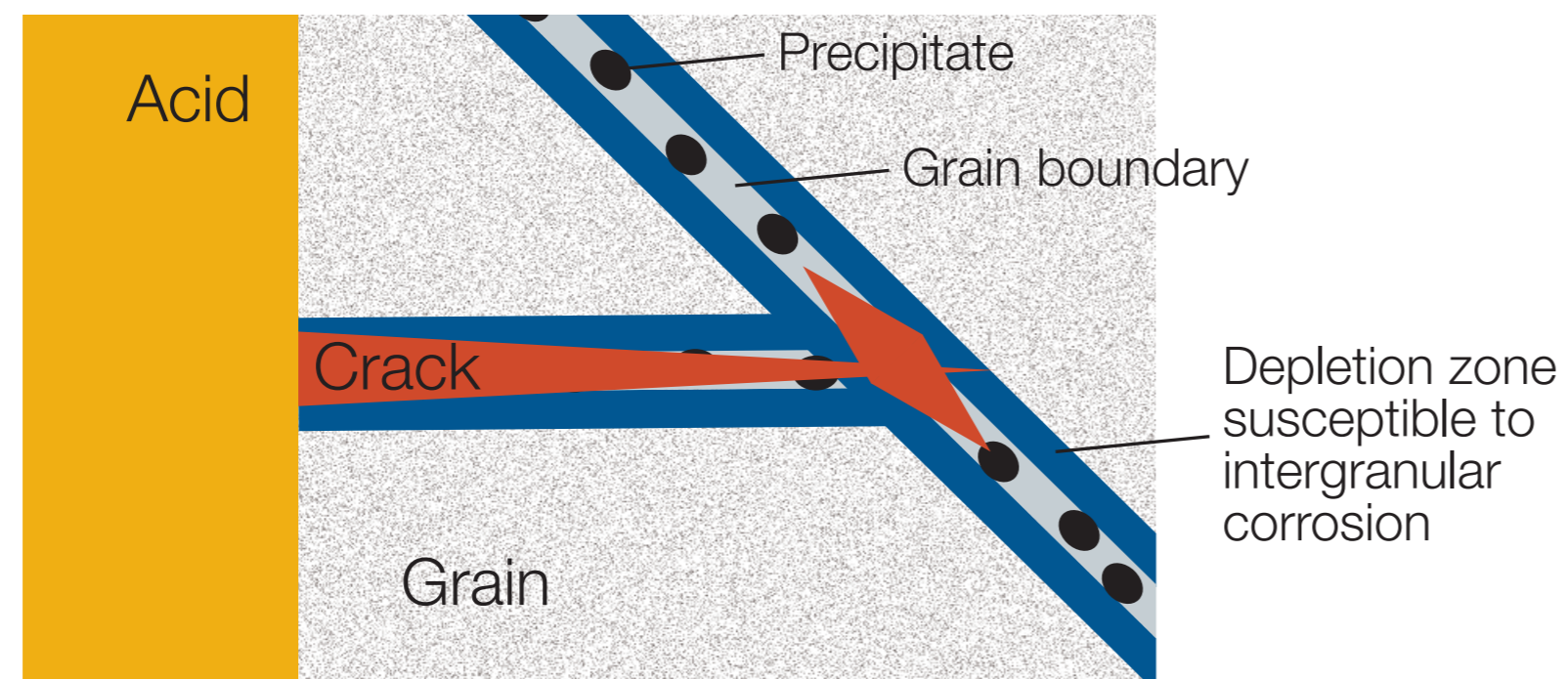



## Galvanic Corrosion

Can occur when two dissimilar materials are in intimate contact with each other and an electrolyte is present

**What it is:** Galvanic corrosion occurs when materials with a dissimilar electrode potential are in contact in the presence of an electrolyte. The passive layer on stainless steel consists of a very thin chromium-rich oxide film that automatically forms in ambient air and protects the material from corrosion. The passive layer makes a material more noble and less susceptible to corrosion. The compatibility of metals can be determined by the Anodic Index, which describes the potential or voltage difference of metals measured in seawater against a standard electrode.

**How it forms:** When the potential difference between two dissimilar metals in the presence of an electrolyte is too great, the material's passive layer begins to break down.

To avoid galvanic corrosion, choose materials with a voltage difference that does not exceed 0.2V. For example, a 316 stainless steel fitting (-0.05V) with 6-Moly tubing (0.00V) would result in a voltage of 0.05V between the two alloys. This voltage is significantly less than 0.2V, meaning the risk of galvanic corrosion is low.

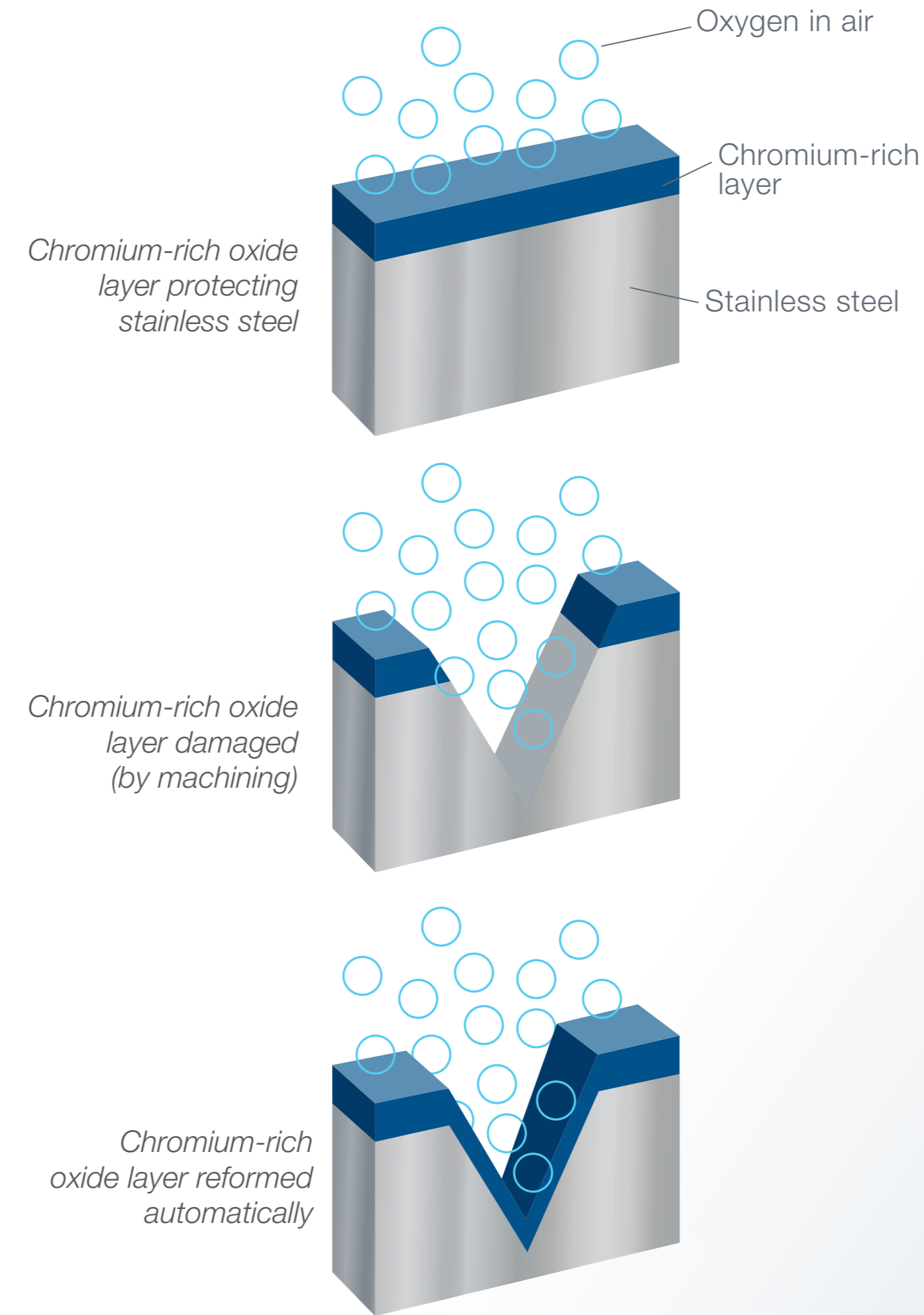

Volts vs. SCE	Material
-1.60	Magnesium
-1.00	Zinc
-0.95	Aluminum
-0.70	Cadmium
-0.60	Steel
-0.50	Type 304 (Active)
-0.40	Type 316 (Active)
-0.35	Naval Brass
-0.30	Muntz Metal
-0.30	Copper
-0.30	Manganese Bronze
-0.25	90-10 Cu-Ni
-0.20	70-30 Cu-Ni
-0.20	Lead
-0.15	Nickel
-0.10	Type 304 (Passive)
-0.05	Type 316 (Passive)
0.00	E-BRITE® Alloy
0.00	AL 29-4C® Alloy
0.00	AL-6XN® Alloy
0.05	Alloy 625, Alloy 276
.010	Titanium
.025	Graphite

SCE stands for Standard Calomel Electrode.

**Anodic Index**  
Highly noble materials with "passive surfaces" are not as susceptible to galvanic corrosion as less noble materials or as noble materials with "active surfaces." In this chart, magnesium is the least noble material, and graphite is the most noble material.

Stainless Steel

### 316 Stainless Steel

In all stainless steels, chromium and nickel are critical for corrosion resistance and ductility. The addition of >10% chromium transforms steel into stainless steel, creating an adherent and invisible oxide layer that is chromium-rich. This oxide layer forms when chromium in the alloy reacts with oxygen in ambient air. This layer gives steel its stainless character. The addition of nickel provides good ductility and ease of forming and welding.

But not all bar stock is the same. Swagelok 316/316L stainless steel tube fittings and instrumentation valves contain more nickel and chromium than minimally required by ASTM standards for bars and forgings.

Note that although stainless steels will not suffer from general corrosion, they can be affected by localized corrosion.

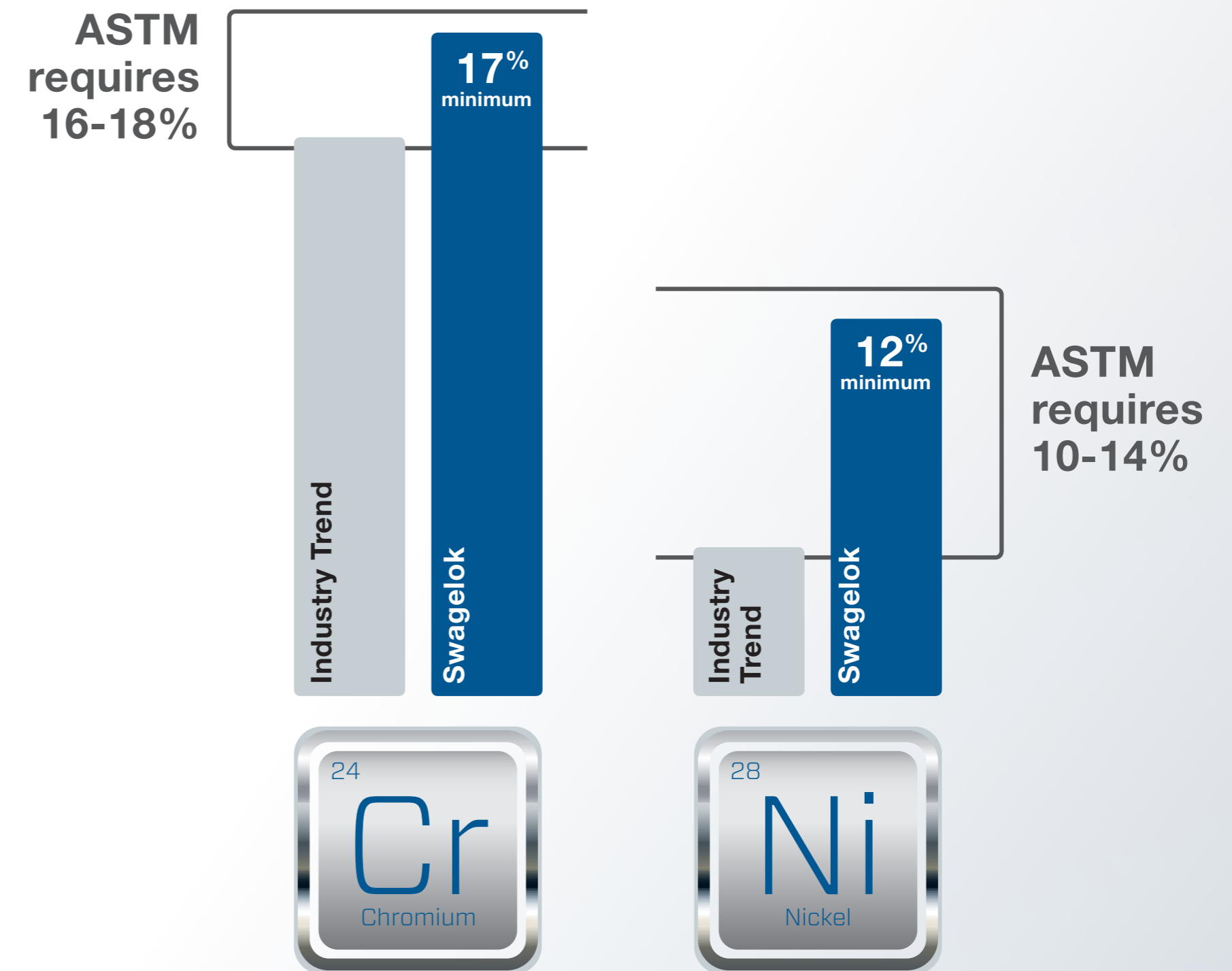

Swagelok 316 stainless steel tube fittings and instrumentation valves exceed minimum ASTM specifications.

**Material Matters:** The risk of stress corrosion cracking (SCC) increases when chloride concentrations, temperatures, and tensile stress are high.

No stainless steel is completely immune to SCC. We have performed SCC testing on pressurized Swagelok tube fittings with exceptional results. [See the test results.](#)





Stainless Steel

## 6-Moly Alloys

6-Moly (6Mo) alloys are superaustenitic stainless steels which contain at least 6% molybdenum and have a PREN of at least 40. Alloy 6HN (UNS N08367) contains 6 weight percent more nickel (Ni) than alloy 254 (UNS S31254). This increase in nickel content gives 6HN added stability with respect to formation of undesirable intermetallic phases. Alloy 6HN has been found to have better corrosion resistance in chloride-containing media than alloy 254.

- Resistance to chloride pitting and crevice corrosion
- Resistance to chloride stress corrosion cracking (CSCC)
- Material yield strength 50% greater than 300-series austenitic stainless steels
- Impact toughness, workability, and weldability
- Suitability for sour gas applications (NACE MR0175/ISO 15156)
- Swagelok 6-Moly products are available from 6HN (UNS N08367) bar stock and forgings qualified to the requirements of the NORSOK M-650 supply chain qualification standard.

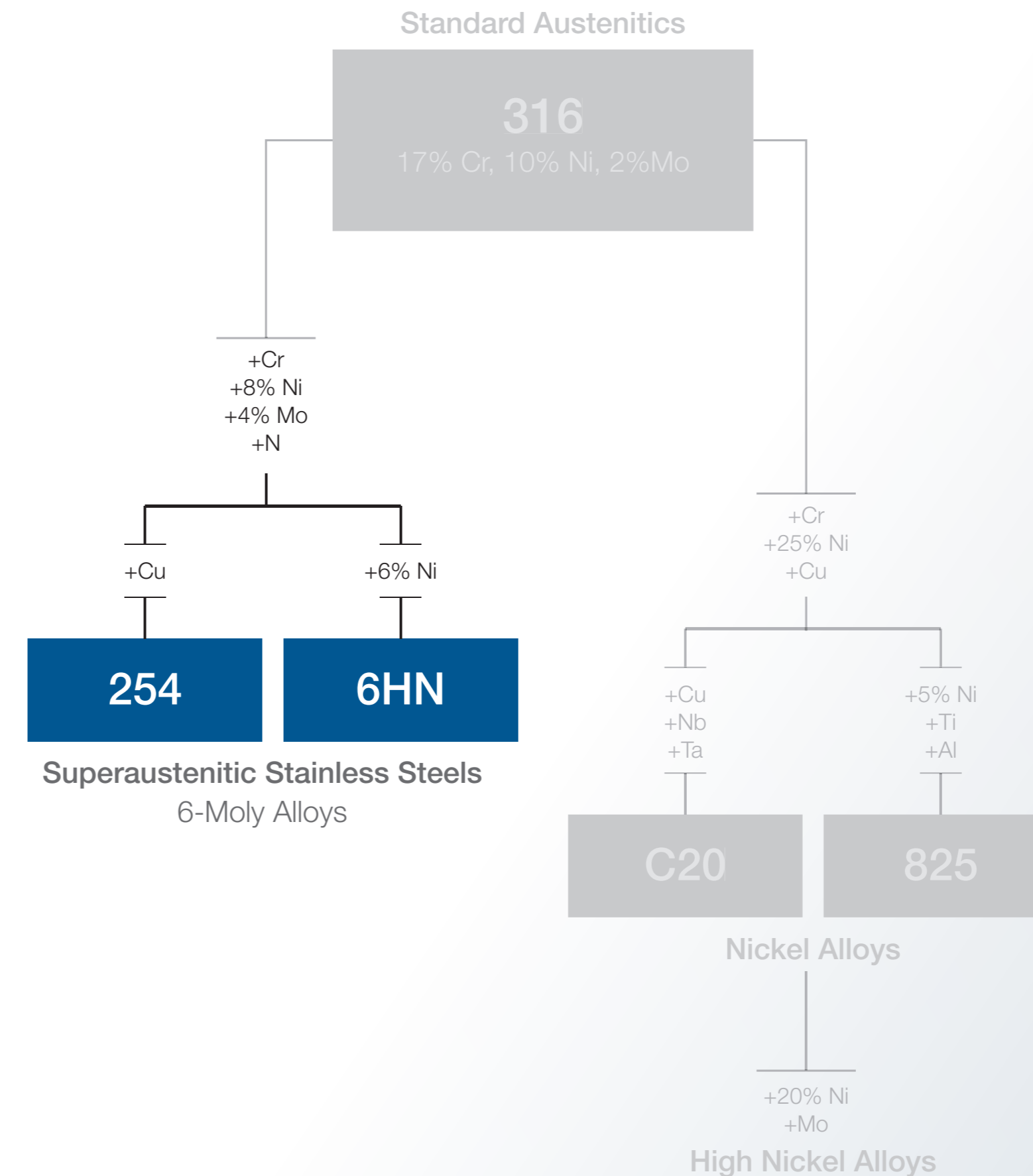

Stainless Steel

## Alloy 2507 Super Duplex Stainless Steel

Duplex stainless steels have a two-phase microstructure of austenite and ferrite grains. This structure gives these materials a combination of attractive properties, including strength, ductility, and corrosion resistance.

Alloy 2507 super duplex, ferritic-austenitic stainless steel is well-suited for service in highly corrosive conditions. Its composition includes nickel, molybdenum, chromium, nitrogen, and manganese, offering excellent resistance to general corrosion, pitting, and crevice corrosion, and stress corrosion cracking (SCC), while maintaining weldability.

- Higher yield and tensile strength for increased pressure ratings
- Compared to 316/316L tubing of same outside diameter and pressure rating, lower wall thickness allows for increased flow of fluids
- Weldability
- Applications up to 482°F (250°C)
- Higher thermal conductivity/lower coefficient of thermal expansion than 316SS
- Suitability for sour gas applications (NACE MR0175/ISO 15156)
- Swagelok 2507 products are available from bar stock and forgings qualified to the requirements of the NORSOK M-650 supply chain qualification standard

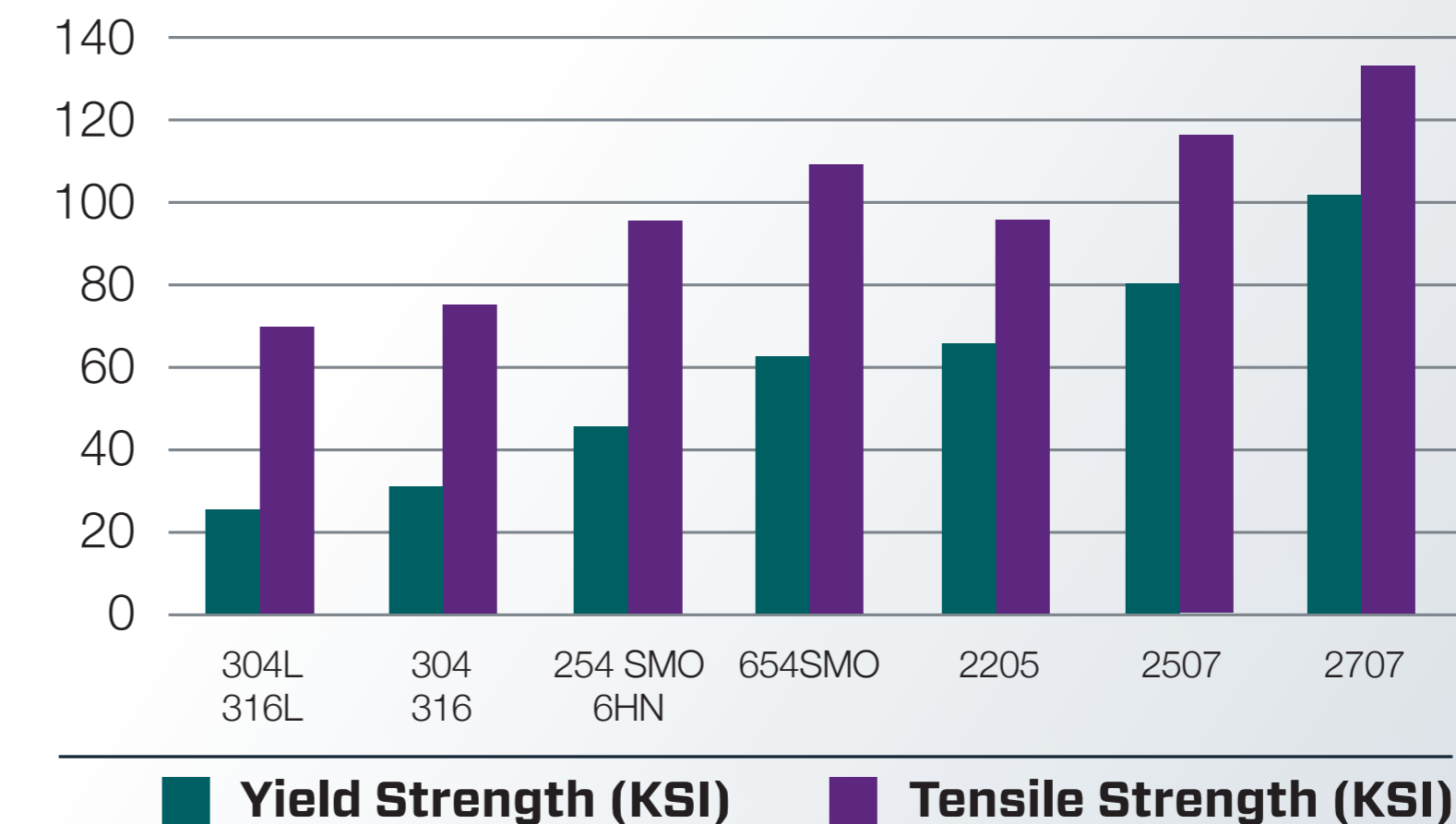
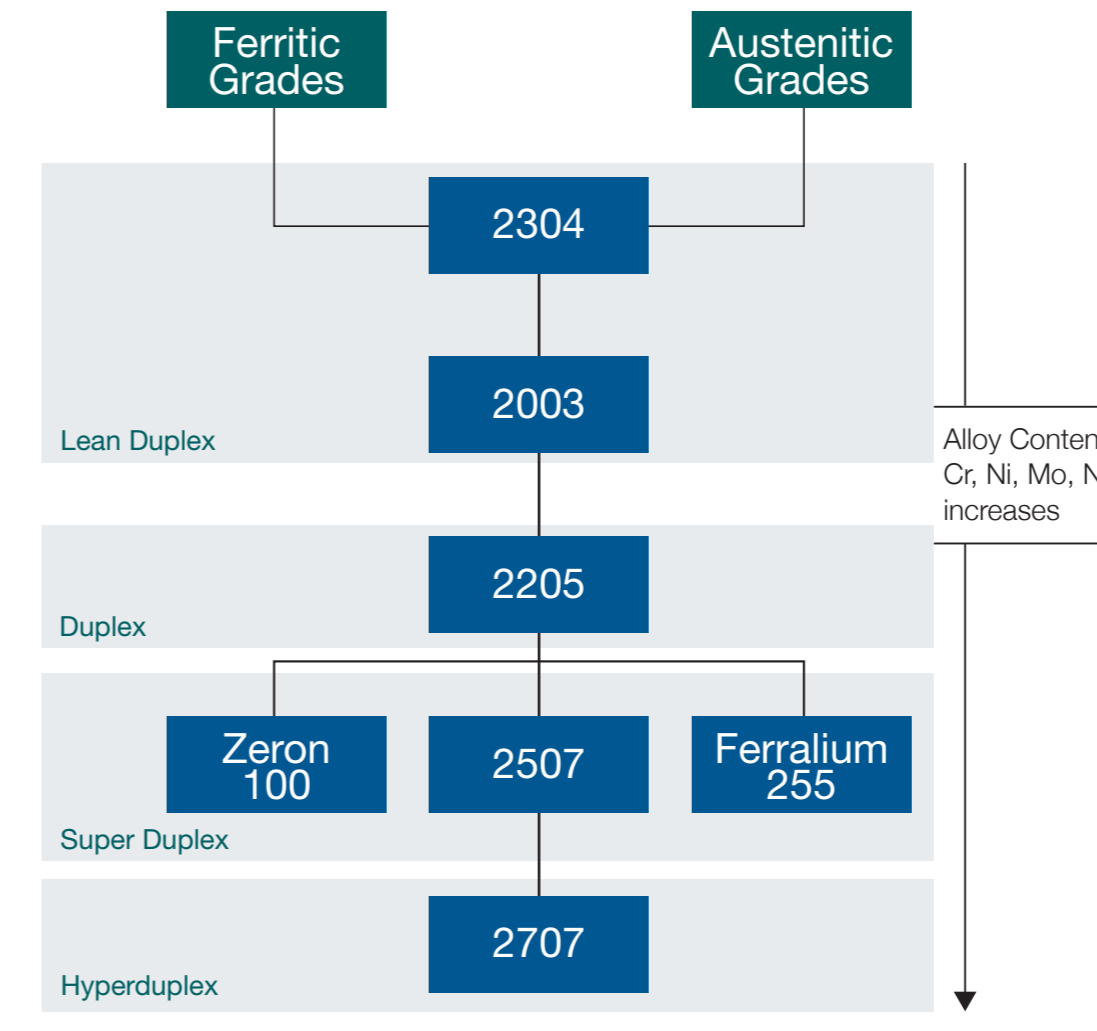

The mechanical properties of alloy 2507 make it a very good choice for high-pressure offshore applications and subsea systems where corrosion, fluid flow, and weight are of concern.

Nickel Alloys

## Alloy 825

Alloy 825 (Incoloy® 825) is a nickel-iron-chromium-molybdenum alloy designed to resist general corrosion, pitting, and crevice corrosion, as well as stress corrosion cracking (SCC), in a wide range of media.

- Resistance to intergranular corrosion due to being stabilized with titanium
- Suitability for sour gas applications (NACE MR0175/ISO 15156)
- Resistance in reducing environments (i.e., sulfuric or phosphoric acid)

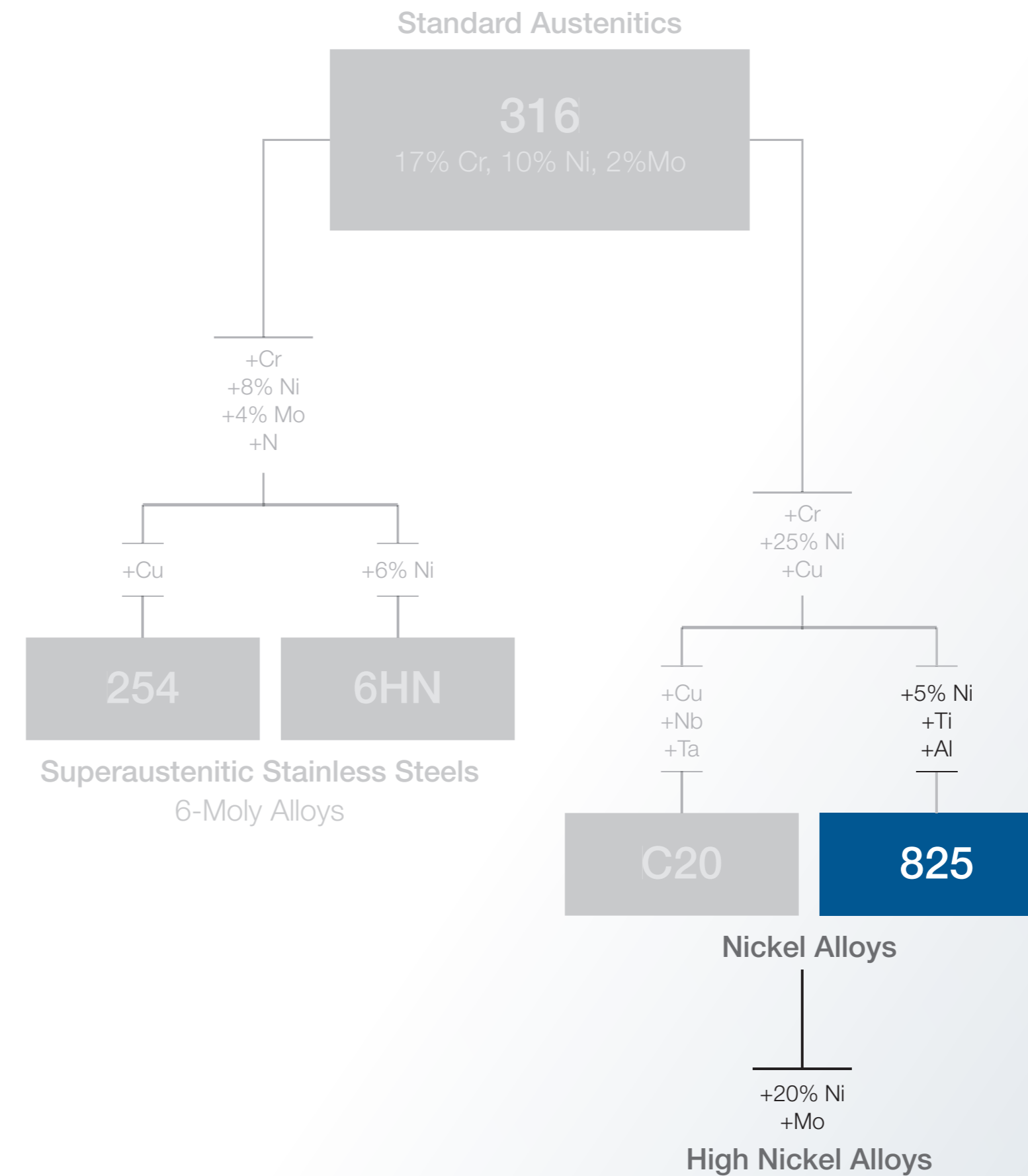

Nickel Alloys

## Alloy 625

Alloy 625 (Inconel® 625) is a nickel-chromium-molybdenum alloy with a small quantity of niobium to reduce the risk of intergranular corrosion in a wide variety of severely corrosive environments.

- Resistance to hydrochloric and nitric acids
- Strength and ductility
- Resistance to crevice and pitting corrosion in high-temperature use
- Suitability for sour gas applications (NACE MR0175/ISO 15156)

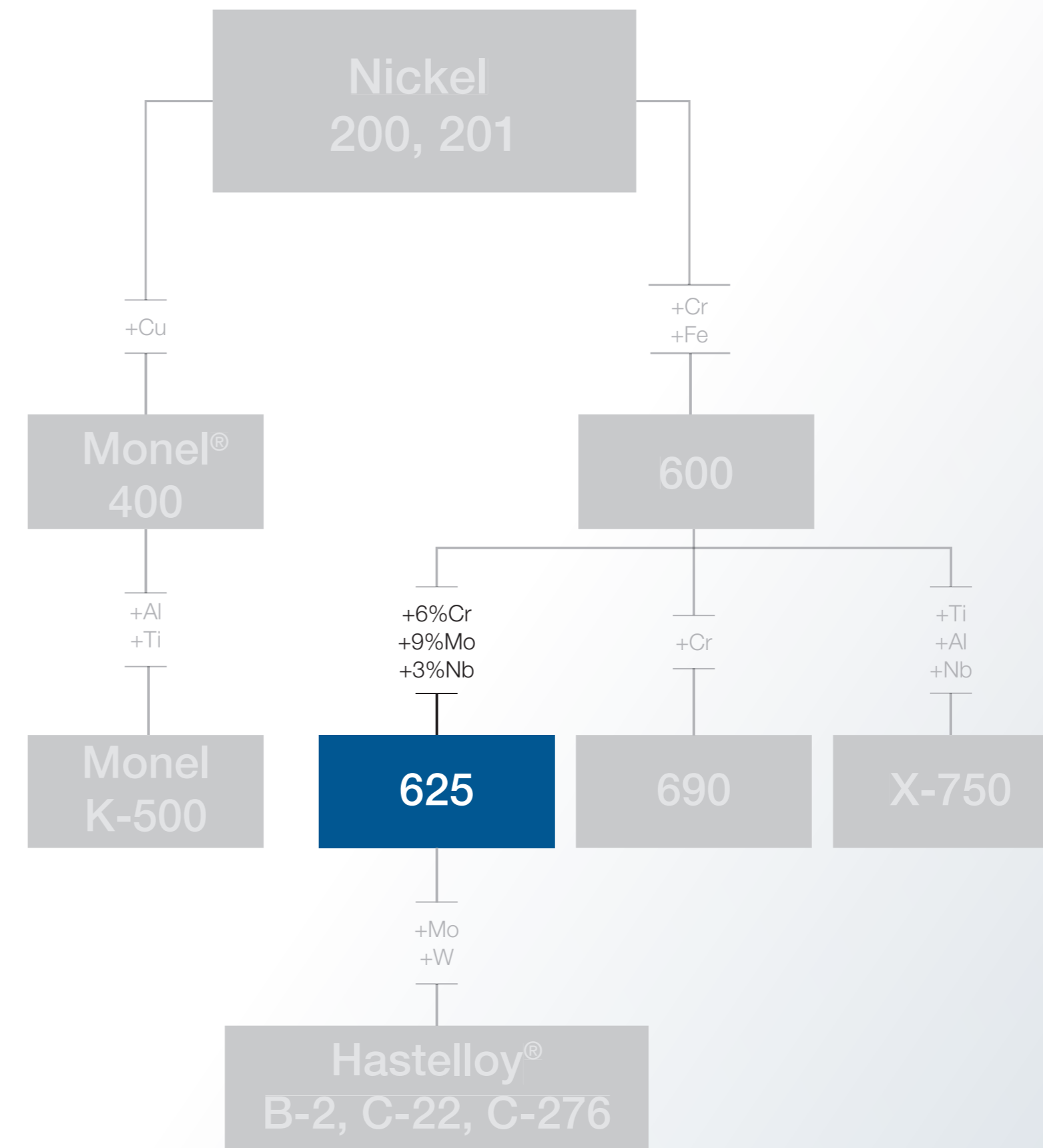

Nickel Alloys

## Alloy C-276

Alloy C-276 (Hastelloy® C-276) contains nickel, molybdenum, and chromium. Its high molybdenum content makes it exceptionally resistant to pitting and crevice corrosion, and it is one of only a few materials that can withstand the corrosive effects of wet chlorine gas, hypochlorite, and chlorine dioxide.

- Resistance to oxidizing and reducing media
- Ductility, toughness, and strength at high temperatures
- Resistance to crevice and pitting corrosion, sulfide stress cracking (SSC), and intergranular corrosion (IGC)
- Suitability for sour gas applications (NACE MR0175/ISO 15156)

Note that this alloy is NOT recommended with highly oxidizing environments, such as hot and concentrated nitric acid.

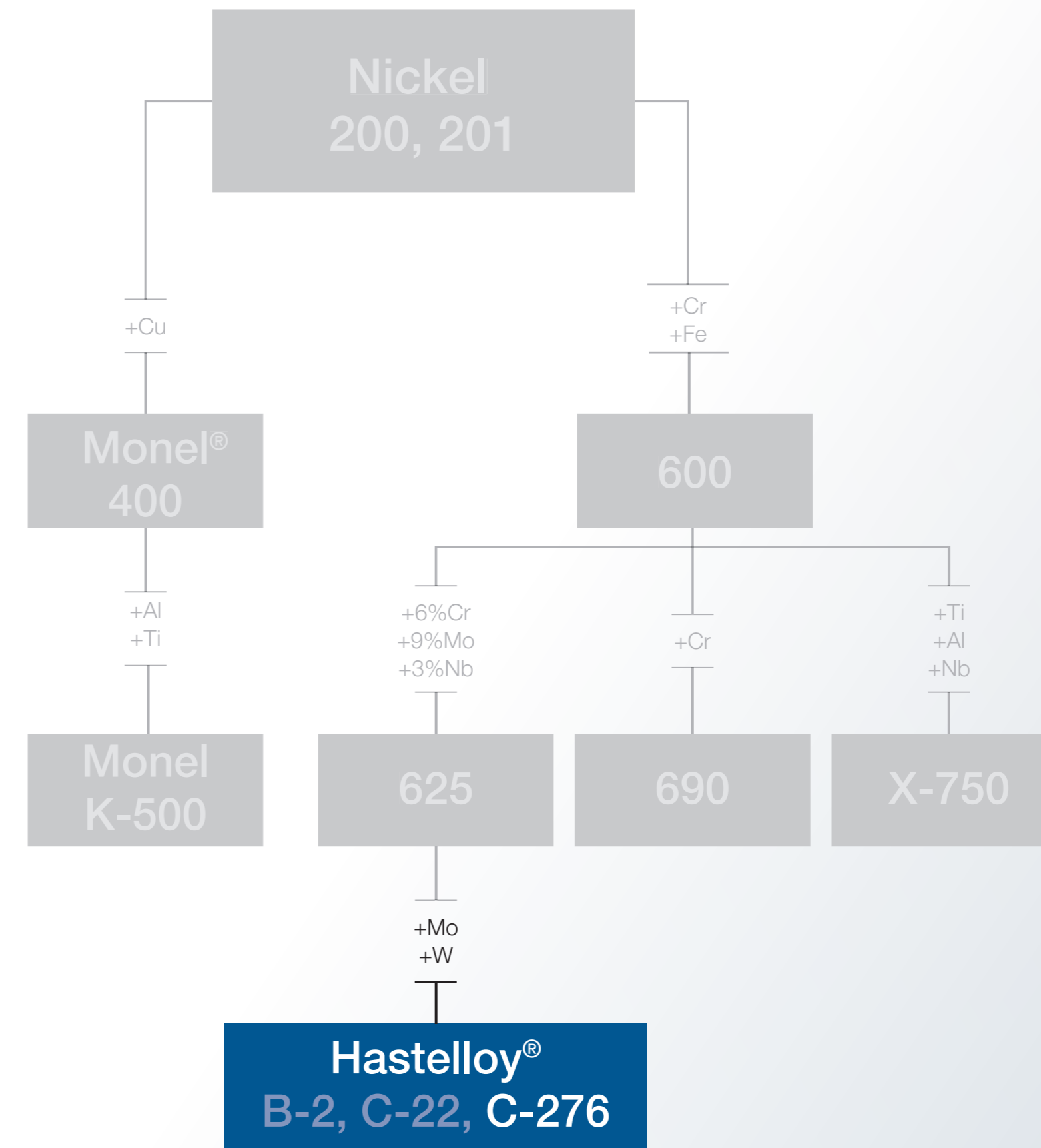

Nickel Alloys

## Alloy 400

Alloy 400 (Monel<sup>®</sup> 400) is a nickel-copper alloy known for its exceptional resistance to hydrofluoric acid, as well as resistance to stress corrosion cracking and pitting in most fresh and industrial waters.

- Strength and corrosion resistance in a wide range of temperatures and media
- Mechanical properties retained at subzero temperatures

Note that stagnant seawater has been shown to induce crevice and pitting corrosion in this alloy.

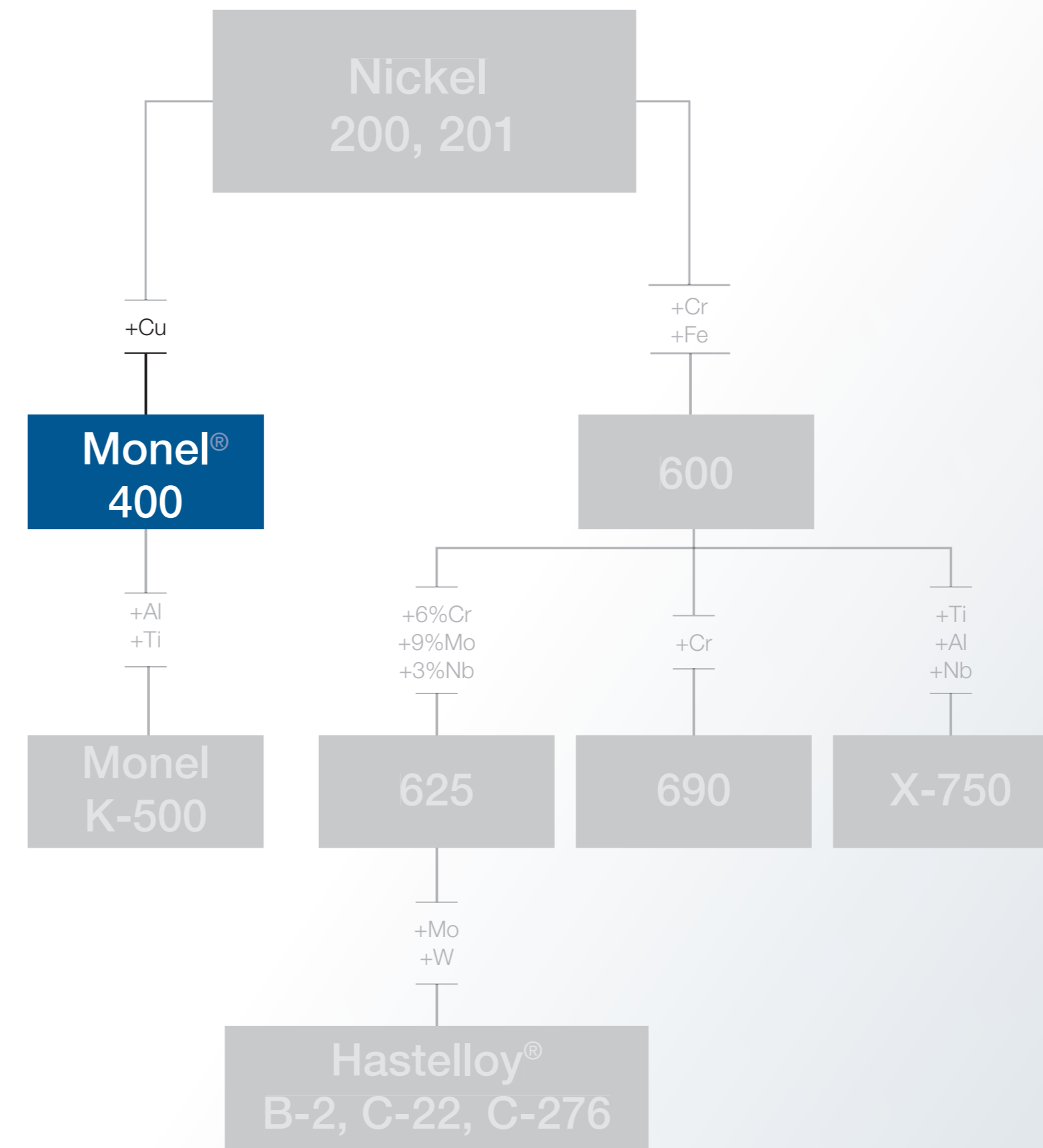

## Titanium Alloys

A stable, strongly adherent oxide film protects titanium alloys from corrosion. This film forms instantly when a fresh surface is exposed to air or moisture. Anhydrous conditions in the absence of a source of oxygen should be avoided since the protective film may not be regenerated if damaged.

Titanium has been used successfully in many applications because of its excellent corrosion resistance in:

- Chloride-containing solutions and moist chlorine gas
- Aqueous solutions of chlorites, hypochlorites, perchlorates, and chlorine dioxide
- Natural and chlorinated seawater to relatively high temperatures

Titanium and its alloys:

- Have exceptionally high resistance to microbiologically induced corrosion (MIC)
- Are highly resistant to oxidizing acids over a wide range of concentrations and temperatures. Common acids in this category include nitric, chromic, perchloric, and hypochlorous (wet  $\text{Cl}_2$ ) acids.

Limiting factors for the application of titanium and its alloys include the following:

- Unalloyed titanium will sometimes corrode in aqueous chloride environments under conditions not predicted by general corrosion rates
- Dry chlorine can cause a rapid attack on titanium and may even cause ignition
- Titanium is unsuitable for use with fluorine gas, pure oxygen, or hydrogen

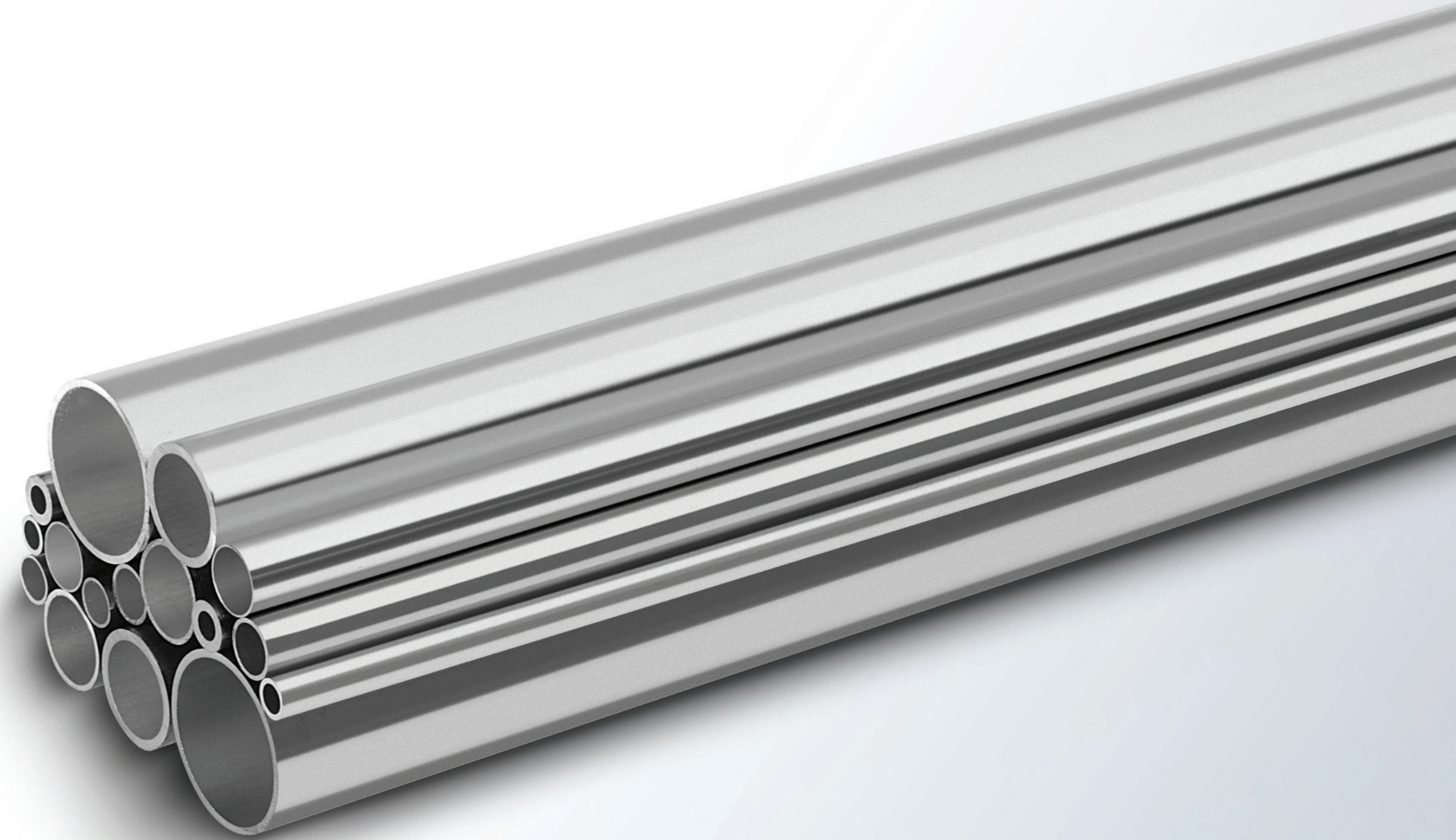

## Engineered Combinations

In marine installations where Swagelok 316/316L stainless steel fittings have performed well, but 316/316L tubing has experienced crevice corrosion in tube clamps, it may be cost-effective to use 316/316L fittings in combination with tubing from a more corrosion-resistant alloy. Engineered combinations use Swagelok 316/316L tube fittings with tubing from alloys 254, 904L, 825, or Tungum® (copper alloy UNS C69100) tubing.

Elevated chromium and nickel levels in 316/316L provide Swagelok tube fittings with higher resistance to localized corrosion. Superior tube grip is achieved with Swagelok's patented hinging-colleting™ back ferrule design that translates axial motion into radial swaging action on the tube, yet operates with a low assembly torque requirement. Swagelok's patented SAT12 low-temperature carburization process is used to case-harden the surface of the back ferrules, which facilitates achieving excellent tube grip on tubing from the above alloys.

Engineered combinations can be a cost-efficient, corrosion-resistant solution that provides these advantages for installations in marine environments:

- Higher nickel and chromium contents in Swagelok standard 316 stainless steel than minimally required by ASTM A479, resulting in a higher PREN value and higher resistance to localized corrosion
- High resistance to pitting and crevice corrosion of special alloy tubing
- Low risk of galvanic corrosion based on positions of 316, 254, 904L, and 825 in galvanic chart, or based on long-term successful use of 316/316L fittings with Tungum tubing.

As with any mixed-material assembly, pressure ratings for tubing and fittings from different alloys are governed by the lower material rating. For pressure ratings, see *Tubing Data – Engineered Combinations* [MS-06-117](#).

### How Corrosion Resistance is Calculated

$$\text{PREN} = \%Cr + 3.3 \times (\%Mo + 0.5W) + 16 \times \%N$$

$$\text{ASTM 316} = 16 + 3.3 \times 2 + 16 \times 0.03 = 23.1 \text{ PREN}$$

$$\text{Swagelok 316} = 17.5 + 3.3 \times 2 + 16 \times 0.03 = 24.6 \text{ PREN}$$

*Pitting Resistance Equivalent Number (PREN) is the measurement of resistance to localized pitting corrosion. Higher PREN values indicate greater pitting corrosion resistance.*





## NACE and Norsok standards

Swagelok fluid system components made from either 316/316L or special alloys are available as products which meet the requirements of the NACE MR0175/ISO 15156 sour gas standard. Valves and fittings from alloys 6HN (UNS N08367) and 2507 are available from bar stock and forgings which are manufactured with processes which have been qualified to the stringent requirements of the Norsok M-650 supply chain qualification standard.

Learn more about:

- › [NACE requirements](#)
- › [NACE MR0175/ISO 15156 Overview](#)
- › [NACE Requirements for Alloy 2507 Super Duplex Tube Fittings](#)
- › [NACE Requirements for Alloy 625 Standard and Medium-Pressure Tube Fittings](#)
- › [NACE Requirements for 6-Moly Alloy Tube, Pipe, and Weld Fittings](#)
- › [Norsok Standards](#)



## NACE Requirements

The NACE MR0175/ISO 15156 standard lists prequalified materials for use in upstream oilfield equipment where sulfide-induced stress corrosion cracking may be a risk in sour environments, i.e., in oil/gas/seawater mixtures where hydrogen sulfide (H<sub>2</sub>S) is present.

The standard allows the use of tube fittings produced from cold-drawn 316 stainless steel and 6-Moly, respectively, in instrumentation and control systems. Nickel alloys can also be used in strain-hardened condition for instrumentation and control systems, and to handle process fluids.

The document includes:

- Requirements for material condition and properties
- Environmental conditions for use of the materials
- Qualifications for material use under specific sour gas conditions

➤ [Read more about NACE](#)

**Material Matters:** Read more about selecting fluid system components for sour oilfields in [Offshore Magazine](#).

## NACE MR0175/ISO 15156 Overview

Alloy	Condition of Alloy	Applicable NACE Table	Application	Maximum Temperature, °C (°F)	Maximum H <sub>2</sub> S Partial Pressure <sup>①</sup> , kPa (psi)
6Mo (254, 6HN)	Solution-annealed and cold-drawn	A.11	Instrument tubing, control-line tubing, and compression fittings	No restrictions; Refer to NACE MR0175/ISO 15156 for cautionary remarks.	
	Solution-annealed	A.8		60 (140)	100 (15)
625	Annealed and cold-drawn	A.14	Any equipment or component	232 (450)	200 (30)
				218 (425)	2000 (300)
	149 (300)	any			
	No restrictions; Refer to NACE MR0175/ISO 15156 for cautionary remarks.				
2507	Solution-annealed and cold-drawn	Not NACE-compliant	N/A		
	Solution-annealed	A.24	232 (450)	20 (3)	

[Read more about NACE](#)

<sup>①</sup> H<sub>2</sub>S partial pressure is the pressure contribution of hydrogen sulfide gas to the total pressure. Example, for partial pressure: Air consists of 21% oxygen; if the total air pressure is 1.00 atm, then the partial pressure of oxygen is 0.21 atm. Consult ANSI/NACE MR0175/ISO 15156 for detailed information on the environmental limits of alloys.



## NACE Requirements for Alloy 2507 Super Duplex Tube Fittings

For a Swagelok alloy 2507 tube fitting to function correctly, the nut and ferrules must be made from cold-drawn bar stock. This material has the strength necessary to grip to 2507 tubing (which has a high surface hardness) and to hold to the high working pressures listed in Swagelok *Tubing Data Sheet*, [MS-01-107](#).

Swagelok alloy 2507 tube fittings with ordering numbers having the -SG2 designator meet NACE MR0175/ ISO 15156 requirements for use in any equipment, according to Table A.24 of the standard, if the fittings are wetted internally, but not externally, by sour gas.

NACE MR0175/ISO 15156 standard requirements for alloy 2507:

- Straight tube fitting bodies are produced from solution-annealed alloy 2507 bar stock
- Shaped tube fitting bodies are produced from solution-annealed alloy 2507 forgings
- External threads of a tube fitting body that are not wetted by the system fluid may be produced by thread rolling
- Internally wetted threads are cut
- Tube fitting nuts are produced from cold-drawn 2507 bar stock but are not wetted by the system fluid
- Back ferrules are produced from cold-drawn 6-Moly bar stock but are not wetted by the system fluid
- Front ferrules are produced from cold-drawn alloy 2507 bar stock
- Nose of the front ferrule comprises a wetted surface; it is under compression and, therefore, not subject to SCC or sour gas cracking, as the standard states a tensile stress component is required to enable these cracking modes
- Port connectors and plug inserts are produced from solution-annealed alloy 2507 bar stock



**Material Matters:** For more information, access Swagelok's full data sheet *Alloy 2507 Super Duplex Tube, Pipe, and Weld Fittings NACE MR0175 Compliant*, [MS-06-115](#).

➤ **Read more about NACE**



## NACE Requirements for Alloy 625 Standard and Medium-Pressure Tube Fittings

For a Swagelok alloy 625 tube fitting and medium pressure tube fitting to function correctly, the nut and ferrules must be made from cold-drawn bar stock.

This material has the strength necessary to grip to alloy 625 tubing and to hold to the high working pressures listed in *Swagelok Tubing Data Sheet*, [MS-01-107](#) and *Swagelok Medium and High-Pressure Fittings and Adapters—Special Alloy Materials*, [MS-02-474](#).

Fittings with bodies made from cold-drawn bar stock meet the requirements of NACE MR0175/ISO 15156 [Table A.14](#). Fittings meeting the requirements of [Table A.13](#) are produced as follows:

- Straight fitting bodies are produced from annealed bar stock
- Shaped fitting bodies are produced from annealed forgings or annealed bar stock
- Nuts are produced from solution-annealed and cold-drawn bar stock, but are not wetted by the system fluid
- Back ferrules are produced from solution-annealed and cold-drawn bar stock, but are not wetted by the system fluid
- Front ferrules are produced from solution-annealed and cold-drawn bar stock
- Nose of the front ferrule comprises a wetted surface; it is under compression and, therefore, not subject to SCC or sour gas cracking, as the standard states a tensile stress component is required to enable these cracking modes
- Plugs, port connectors, and tube adapters are produced from annealed bar stock



> **Read more about NACE**

## NACE Requirements for 6-Moly Alloy Tube, Pipe, and Weld Fittings

The NACE MR0175/ISO 15156 standard contains tables that describe material requirements and environmental limits for materials used in upstream sour gas applications. The NACE MR0175/ISO 15156 tables that define requirements for 6-Moly alloys are [Tables A.8 and A.11](#).

[Table A.8](#) specifies the environmental and material limits for highly alloyed austenitic stainless steels used for any equipment or components in any type of sour gas installation.

[Table A.11](#) defines the environmental and material limits for highly alloyed austenitic stainless steels used as instrument tubing, control-line tubing, compression fittings, and surface and downhole screen devices.

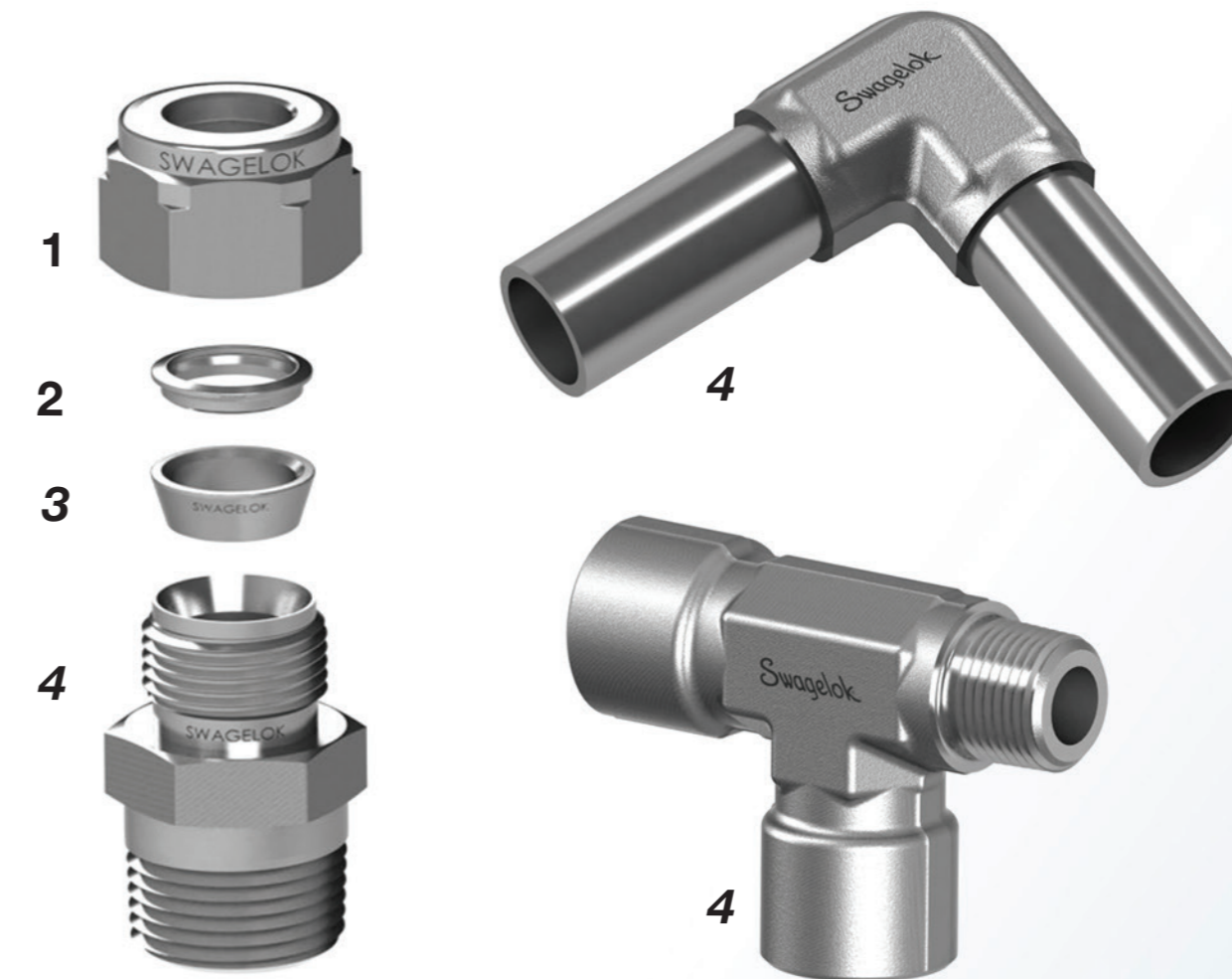

Component	Material	ASTM Specification	Marking
1 Nut	Alloy 254 (UNS S31254) or Alloy 6HN (UNS N08367)	A479 <sup>①</sup>	254 or 6HN on face
2 Back ferrule	6HN (UNS N08367)	A479 <sup>②</sup>	6HN on outer rim
3 Front ferrule	Alloy 254 (UNS S31254) or Alloy 6HN (UNS N08367)	A479 <sup>①</sup>	254 or 6HN on outer rim
4 Body	Alloy 254 (UNS S31254) or Alloy 6HN (UNS N08367)	Straight body—A479 <sup>①</sup> Shaped body—A182	Tube and pipe fittings— 254 or 6HN on neck Weld fitting— 254 or 6HN on body Pipe and weld fittings— SG on body

Wetted components listed in *italics*

① A479 (except for elongation, area of reduction, and hardness when cold-drawn bar)

② A479 (except for elongation and hardness)

**Material Matters:** For more information, access Swagelok’s full data sheet *6-Moly Alloy Tube, Pipe, and Weld Fittings/NACE MR0175/ISO 15156 Compliant*, [MS-06-122](#).

## NORSOK Standards

NORSOK standards (developed by the Norwegian petroleum industry) outline material and supply chain requirements focused on:

- Ensuring the safety and cost-effectiveness of operations
- Replacing oil company specifications
- Providing a basis for international standardizations process
- Withdrawing standard upon publication of international standard

In response to the growing interest in NORSOK-approved products, Swagelok is pleased to quote orders for tube fittings, pipe fittings, and select general industrial valve products manufactured from NORSOK-certified material.

We offer products manufactured from alloy 2507, 254, and 6HN bars and forgings that meet the requirements of the NORSOK M-650 supply chain qualification standard.

[> Read more about NORSOK](#)



## NORSOK Standards

The table provides details of the standards.

Standard	Description
M-650: Qualification of Manufacturers of Special Materials	<p>Covers a set of qualification requirements to verify that the manufacturer has:</p> <ul style="list-style-type: none"> <li>• Sufficient competence and experience with the relevant material grades</li> <li>• Necessary facilities and equipment to manufacture these grades in the required shapes and sizes with acceptable properties</li> </ul> <p>Also covers data sheets for different product forms, including seamless pipes, welded pipes, fittings, forgings, plate, castings, bars, and tubes.</p>
M-001: Materials Selection	<p>Provides guidance, in conjunction with ISO 21457, for materials selection for oil and gas production on offshore installations, including:</p> <ul style="list-style-type: none"> <li>• Corrosion protection and control</li> <li>• Design limitations for specific materials</li> <li>• Qualification requirements for new materials and applications</li> </ul>
M-630: Material Data Sheets and Element Data for Piping	<p>Provides data sheets for the following materials:</p> <p>Carbon steels: Type 235, Type 235LT, Type 360LT                      Ferritic/Austenitic stainless steels: Type 22Cr, Type 25Cr</p> <ul style="list-style-type: none"> <li>• Copper/Nickel 90/10 and other copper alloys</li> <li>• Nickel base alloys: Type 625</li> <li>• Polymers, including fiber-reinforced</li> <li>• Austenitic stainless steels: Type 6Mo</li> <li>• Austenitic stainless steels: Type 316</li> <li>• Titanium</li> <li>• High-strength, low-alloyed steels</li> </ul>



## Materials Science Training

### Make the best choices for your application

Swagelok offers *Materials Science Training*. Learn more about selecting the optimal corrosion-resistant material for applications which require products to have specific pressure ratings, are used at very low or very high temperatures, must withstand corrosive threats, must be compliant with certain industry standards, or must meet unique performance requirements.

- Choose proper materials to keep your fluid systems leak-tight and operating efficiently
- Discover how specific alloys resist corrosion, how materials behave, and how industry standards impact your material choice

### What You'll Learn

- Principles of materials science, corrosion, and other factors affecting material properties
- Types of corrosion and how specific alloys resist corrosion
- How to select optimal materials of construction for demanding applications based on pressure and temperature ratings, corrosive threats, and compliance
- How to select proper components to address sour gas corrosion and NACE standards
- Critical concepts covering the nature and behavior of materials, including an atom-level view of metals, as well as the microstructural characteristics and mechanical properties of materials



## Additional Resources

### Quality and Reliability

For any fluid system solution to deliver high-caliber performance and long life, the design and material must work together. That's why Swagelok doesn't just have a dedicated quality department—our entire company is committed to excellence, including product ratings and test reports for all special alloys.

Rather than buy materials off the shelf, we choose to strictly control quality by:

- Holding mills to tighter alloy and quality specifications
- Employing positive material identification
- Making our own tooling
- Using technology-based methods of nondestructive testing
- Staffing dedicated engineers who work exclusively with the supply chain

These measures enhance material consistency and help prevent defects from reaching the final product. Once installed in your system, everything we sell is backed by our [Limited Lifetime Warranty](#).

 [Read more about Additional Resources](#)

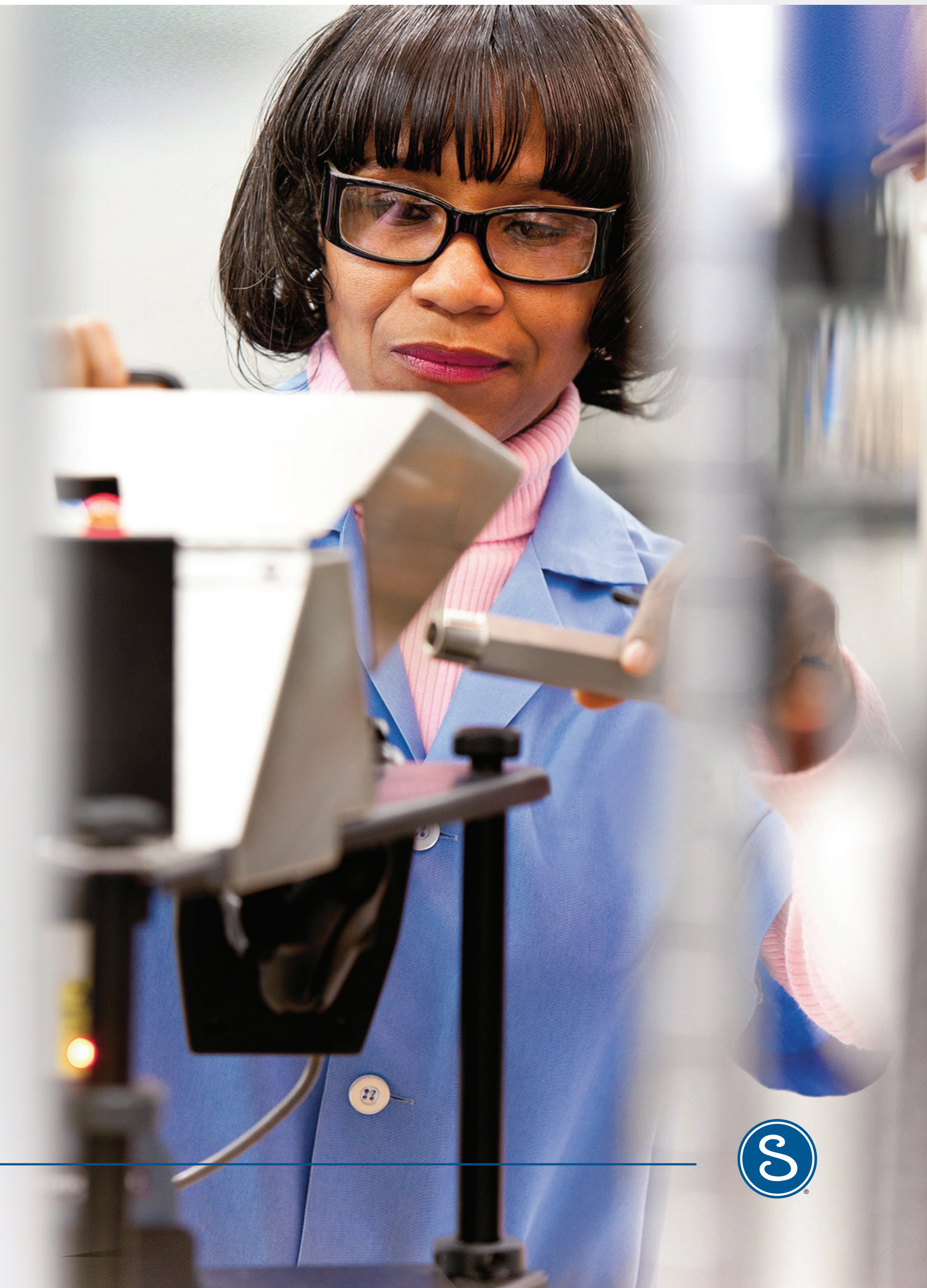

## Additional Resources

### **[Product and Systems Training](#)**

Learn more about fluid systems and enhance your team's capabilities with our complete suite of training programs.

### **[Evaluation and Advisory Services](#)**

When you need extra support, we can survey your site to evaluate and troubleshoot sampling systems, hose, steam systems, and more.

### **[Swagelok® Custom Solutions](#)**

We can help you design, specify, and build fluid system assemblies. We produce a professional, repeatable solution, with testing, inspection, and packaging – all with Swagelok's [Limited Lifetime Warranty](#).

### **[Find a Technical Advisor](#)**

Want to talk more about your material requirements? Contact your Swagelok authorized sales and service center.

**> Read more about Additional Resources**



## Additional Resources

Use the links below to access other helpful reference materials:

### Articles

[World Oil](#): Preventing pitting and crevice corrosion of offshore stainless steel tubing

[Offshore Magazine](#): Selecting fluid system components for use in sour oilfields

### Reference Guide

[Tubing Data Sheet](#) MS-01-107

[Tubing Data - Engineered Combinations](#) MS-06-117

### Product Test Reports

Chloride Stress Corrosion Cracking (CSCC) Test of 316 Stainless Steel Swagelok® Tube Fitting Engineered Combinations

[PTR-4183](#) - Chloride Stress Corrosion Cracking Test

Super Austenitic 254 SMO® (6-moly) Stainless Steel Tubing With Stainless Steel Swagelok® Tube Fittings

[PTR-2834](#) - Tensile Pull Test

[PTR-2835](#) - High-Temperature Thermal Cycling and Hydrostatic Proof Test

[PTR-2836](#) - Low-Temperature Thermal Cycling and Hydrostatic Proof Test

[PTR-2841](#) - Rotary Flexure Test

[PTR-2849](#) - Hydraulic Impulse Test and Hydrostatic Proof Test

[PTR-2852](#) - Hydrostatic Pressure Test

[PTR-2853](#) - Nitrogen Gas Seal Test with Repeated Reassembly

### NACE and NORSOK

NACE and NORSOK Compliant Valves [SCS-00193](#)

## SAFE PRODUCT SELECTION

When selecting a product, the total system design must be considered to ensure safe, trouble-free performance. Function, material compatibility, adequate ratings, proper installation, operation, and maintenance are the responsibilities of the system designer and user.